

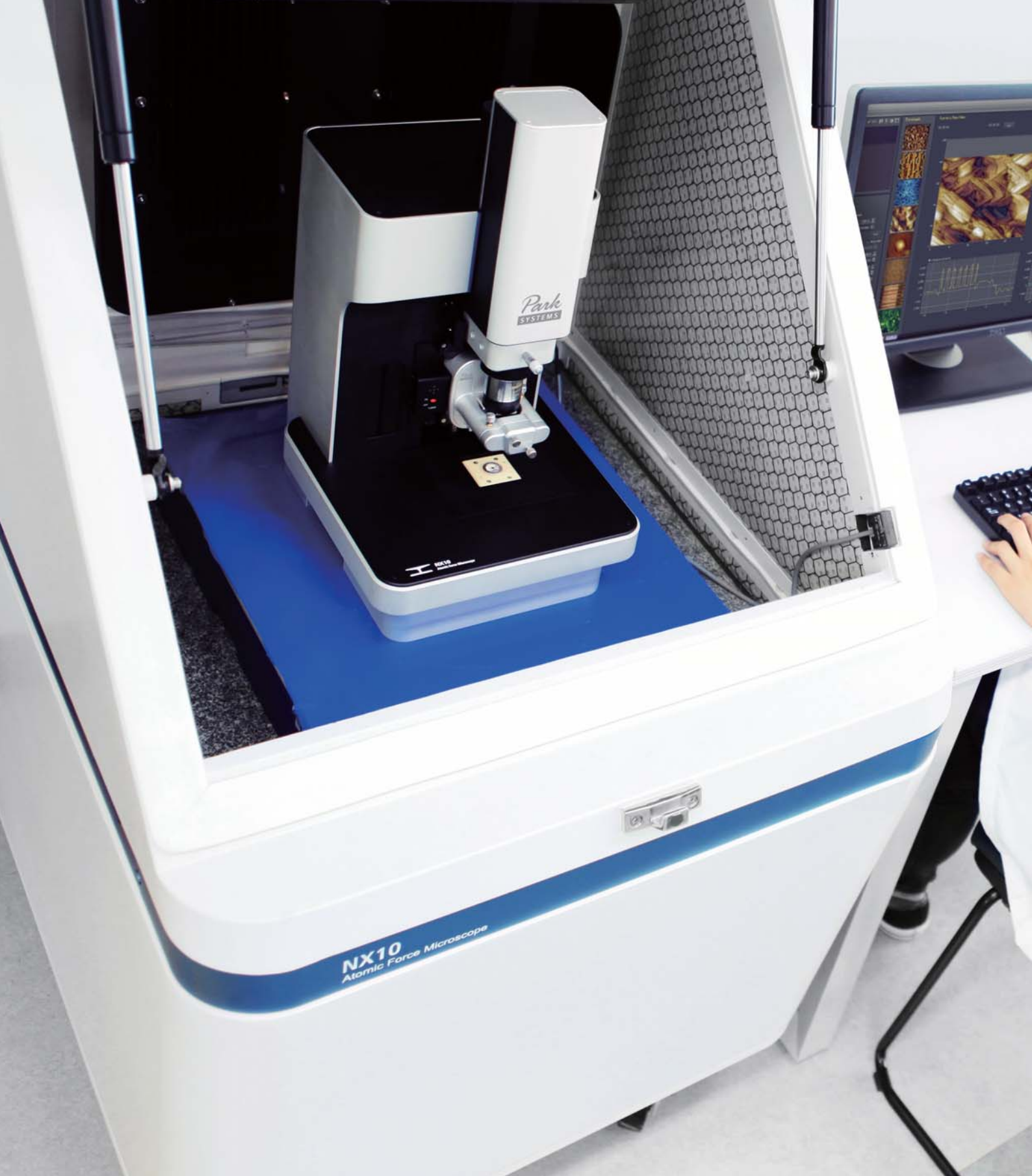

The Most Accurate Atomic Force Microscope

Park NX10

The quickest path to innovative research



Park Systems The Most Accurate Atomic Force Microscope



Park NX10

The premiere choice for nanotechnology research

Better accuracy means better data

Park NX10 produces data you can trust, replicate, and publish at the highest nano resolution. It features the world's only true non-contact AFM that prolongs tip life while preserving your sample, and flexure based independent XY and Z scanner for unparalleled accuracy and resolution.

Better accuracy means better productivity

From sample setting to full scan imaging, measurement, and analysis, Park NX10 saves you time every step of the way. The user friendly interface, easy laser alignment, automatic tip approach, and analysis software allow you to get publishable results faster.

Better accuracy means better research

With more time and better data, you can focus on doing more innovative research. And the Park NX10's wide range of measurement modes and customizable design means it can be easily tailored to the most unique projects.



Park NX10

Innovative features for innovative work

Accurate XY Scan by Crosstalk Elimination

- Two independent, closed-loop XY and Z flexure scanners for sample and probe tip
- Flat and orthogonal XY scan with low residual bow
- Out-of-plane motion of less than 1 nm over an entire scan range
- Z scanner linearity deviation of less than 0.015% over an entire scan range
- Accurate height measurements without any need for software processing

Accurate AFM Topography with Low Noise Z Detector

- Sample topography measured by industry leading low noise Z detector
- True Sample Topography™ without edge overshoot or piezo creep error
- Accurate surface height recording, even during high-speed scanning
- Reduced XY scanner ringing by forward sine-scan algorithm
- Industry leading forward and backward scan gap of less than 0.15%

Best Tip Life, Resolution and Sample Preservation by True Non-Contact™ Mode

- Industry leading Z-scanner bandwidth of more than 9 kHz
- Fastest Z-servo speed of more than 62 mm/sec tip velocity
- Minimum tip wear for prolonged high-quality and high-resolution imaging
- Minimized sample damage or modification
- Immune from parameter-dependent results common in tapping imaging

The Most Comprehensive and Extensible AFM Solution

- The most extensive range of SPM modes
- The largest number of sample measurement options
- The best option compatibility and upgradeability in the industry
- 24 bit digital electronics with three internal lock-ins, Q-control, and spring constant calibration
- Active temperature control of acoustic enclosure

The Best User Convenience by Design

- Open side access for easy sample or tip exchange
- Easy, intuitive laser alignment with pre-aligned tip mount
- Easy head removal by dovetail-lock mount
- Direct on-axis optics for high resolution optical viewing
- Fast automatic tip approach to sample surface within 10 seconds

Park NX10

AFM Technology

Flat Orthogonal XY Scanning Without Scanner Bow

Park's Crosstalk Elimination removes scanner bow, allowing flat orthogonal XY scanning regardless of scan location, scan rate, and scan size. It shows no background curvature even on flattest samples, such as an optical flat, and with various scan offsets. This provides you with a very accurate height measurement and precision nanometrology for the most challenging problems in research and engineering.

Decoupled XY and Z Scanners

The fundamental difference between Park and its closest competitor is in the scanner architecture. Park's unique flexure based independent XY scanner and Z scanner design allows unmatched data accuracy in nano resolution in the industry.

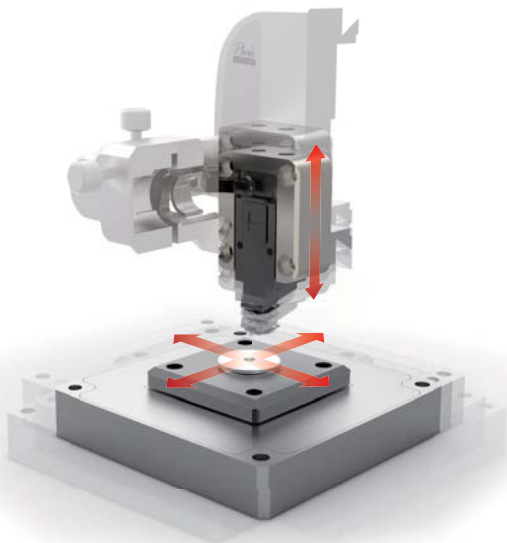

Accurate Surface Measurement

"Flat" sample surface as it is!

- Low residual bow
- No need for software processing (raw data)
- Accurate results independent of scan location

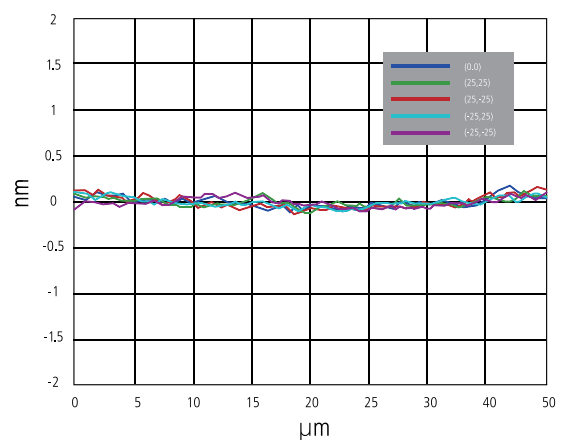
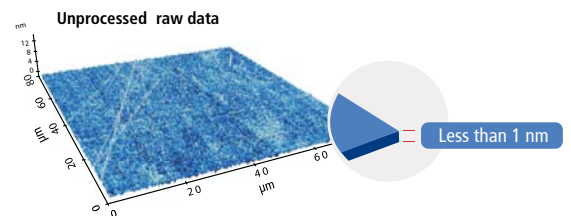

Industry Leading Low Noise Z Detector

Our AFMs are equipped with the most effective low noise Z detectors in the field, with a noise of .02 nm over large bandwidth. This produces highly accurate sample topography, no edge overshoot and no need for calibration. Just one of the many ways Park NX10 saves you time and gives you better data.

Accurate Sample Topography Measured by Low Noise Z Detector

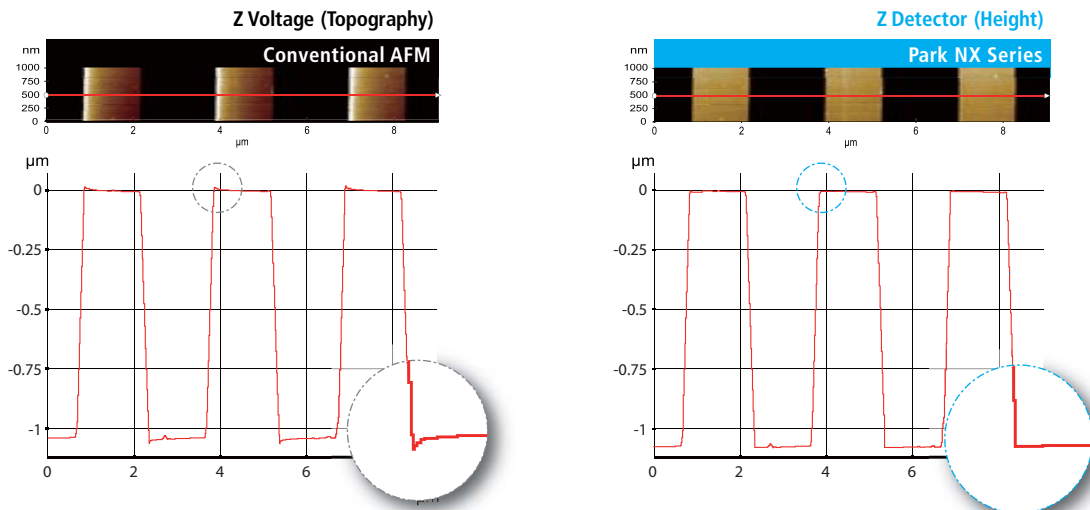

Sample: 1.2 μm Nominal Step Height (9 μm x 1 μm, 2048 pixels x 128 lines)

Piezoelectric creep effect

No creep effect

No artifact by AFM scanner in low noise closed-loop topography

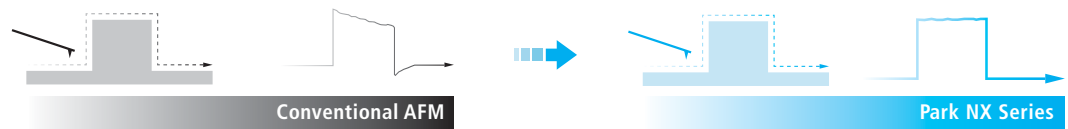

- Uses low noise Z detector signal for topography
- Has low Z detector noise of 0.02 nm over large bandwidth
- Has no edge overshoot at the leading and trailing edges
- Needs calibration done only once at the factory

Park NX10

Equipped with the most innovative AFM technology

1 2D Flexure-Guided Scanner with 50 μm x 50 μm Scan Range

The XY scanner consists of symmetrical 2-dimensional flexure and high-force piezoelectric stacks. It provides high orthogonal movement with minimal out-of-plane motion and high responsiveness that is essential for precise sample scanning in the nanometer scale. The compact and rigid structure of Park NX10 enables low noise, high-speed servo response.

2 High Speed Z Scanner with 15 μm Scan Range

Driven by a high-force piezoelectric stack and guided by a flexure structure, the standard Z scanner has a high resonant frequency of more than 9 kHz (typically 10.5 kHz) and an ultra fast Z-servo speed of more than 48 mm/sec tip velocity. The maximum Z scan range can be extended from 15 μm to 30 μm with the optional long range Z scanner.

3 Low Noise XYZ Position Sensors

The industry leading low noise Z detector replaces the applied Z voltage as the topography signal while the low noise XY closed loop scan minimizes the forward and backward scan gap to less than 0.15% of the scan range.

4 Motorized XY Sample Stage

The measurement location of the sample is easily controlled by the integrated manual XY stage. The travel range of the XY sample stage is 20 mm x 20 mm.

5 Step-and-Scan Automation

Using the motorized sample stage, Step-and-Scan enables programmable multiple region imaging. Here's how it works:

- 1 Scan an image
- 2 Lift cantilever
- 3 Move motorized stage to a user defined coordinate
- 4 Approach
- 5 Repeat scan

This automated feature greatly increases productivity by reducing the need for your interaction during the scan process.

6 Accessible Sample Holder

The Park NX10's unique head design handles up to 50 mm x 50 mm x 20 mm (width x length x height) sample size, and it allows easy side access to the sample and tip.



7 Expansion Slot for Advanced SPM Modes and Options

Advanced SPM modes are easily enabled by plugging an optional module into the expansion slot. And the modular design of the NX-series allows for module compatibility throughout the line.

8 Direct On-Axis High Powered Optics with Integrated LED Illumination



The Park NX10's custom designed objective lens with an ultra long working distance (10 mm, WD 0.21 NA, 1.0 μm resolution) provides direct on-axis optical view with unprecedented clarity. This allows users to navigate the sample surface easily, and find the target area quickly. With the EL20x objective lens of long travel head, the enlarged sensor size of the CCD provides a resolution of 0.7 μm without losing visual quality.

9 Auto Engage by Slide-to-Connect SLD Head

The AFM head is easily inserted or removed by sliding it along a dovetail rail. This automatically locks the head into its pre-aligned position and connects it to the control electronics with a positioning repeatability of a few microns. The low coherency of the Super Luminescence Diode (SLD) enables accurate imaging of highly reflective surfaces and precise measurements for pico-Newton Force-distance spectroscopy. The SLD wavelength eliminates interference issues for users interested in combining the AFM with experiments in the visible

10 Vertically Aligned Motorized Z Stage and Focus Stage

The Z stage and focus stage engage the cantilever with the sample surface while constantly maintaining a clear field of vision for the user. And because the focus stage is motorized and software controlled, it has the precision necessary for transparent samples and liquid cell applications.

High Speed 24-bit Digital Electronics

All the NX-series AFMs are controlled and processed by the same NX electronics controller. The controller is an all digital, 24-bit high speed electronics which successfully realizes the True Non-Contact™ mode for accuracy and speed. With its low noise design and high speed processing unit, the controller is also ideal for precise voltage and current measurement as well as nanoscale imaging. The embedded digital signal processing capability adds to the functionality and the economics of our AFM solutions for advanced researchers.

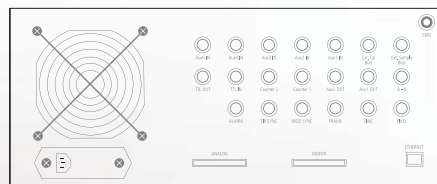

24-bit signal resolution for XY and Z detectors

- 0.003 nm resolution in XY (50 μm XY)
- 0.001 nm resolution in Z (15 μm Z)

Embedded digital signal processing capability

- 3 channels of flexible digital lock-ins
- Spring constant calibration (thermal method)
- Digital Q control included

Integrated signal access ports

- Dedicated and programmable signal input/output ports
- 7 inputs and 3 outputs

Park NX10

Why the world's most accurate small sample AFM is also the easiest to use



Easy Snap by Hand

Easy Tip and Sample Exchange

The unique head design allows easy side access allowing you to easily snap new tips and samples into place by hand. The cantilever is ready for scanning without the need for any tricky laser beam alignment by using pre-aligned cantilevers mounted on to the cantilever tip holder.

Easy, Intuitive Laser Beam Alignment

With our advanced pre-aligned cantilever holder, the **laser beam** is focused on the cantilever upon placement. Furthermore, the natural on-axis top-down view, the only one in the industry, allows you to easily find the laser spot. Since the laser beam falls vertically on the cantilever, you can intuitively move the laser spot along the X- and Y-axis by rotating its two positioning knobs. As a result, you can easily find the laser and position it on PSPD using our beam alignment user interface. From there, all you will need is a minor adjustment to maximize the signal to start acquiring the data.



Laser beam is always focused on the cantilever upon replacement

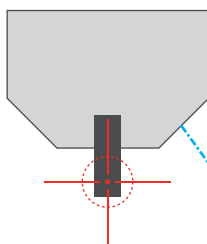

Lightning Fast Automatic Tip Approach

Our automatic tip to sample approach requires no user intervention and engages in just 10 seconds after loading the cantilever. By monitoring the cantilever response to the approaching surface, Park NX10 can initiate an automatic fast tip to sample approach within 10 seconds of cantilever loading. Fast feedback by the high speed Z scanner and low noise signal processing by the NX electronics controller enable quick engagement to the sample surface without any user intervention. It just works, minimal user involvement required.



Active Temperature Controlled Acoustic Enclosure

Designed exclusively for Park NX10, the Acoustic Enclosure is actively temperature-controlled for a perfectly stable thermal environment. The Park NX10 also features active vibration isolation and is completely isolated from external acoustic and light noise so that nothing can interfere with its accuracy.

- **Easy to use controls** - Innovative control design allows Park NX10 to quickly reach temperature equilibrium
- **Get scanning faster** - Temperature stability of less than 0.05 °C within 10 minutes of closing the Acoustic Enclosure door

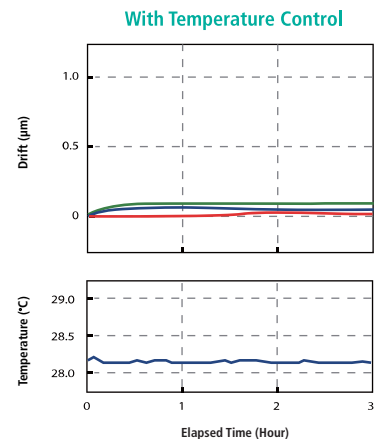
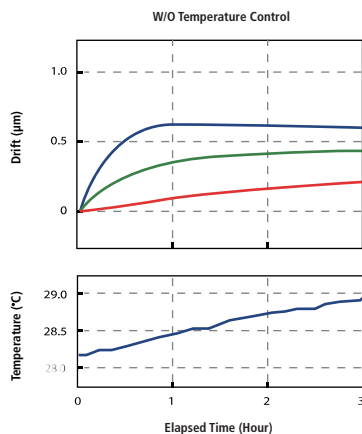
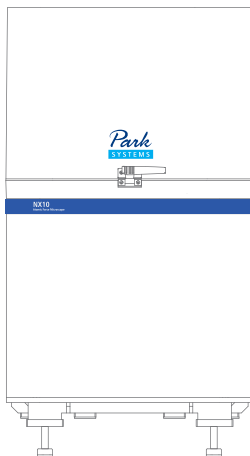

Park NX10

Adaptable to any project

The wide range of scanning modes and modular design of the NX series allows it to be easily tailored to the needs of any scanning probe microscopy project.

Standard Imaging

- True Non-Contact AFM
- Basic Contact AFM
- Lateral Force Microscopy (LFM)
- Phase Imaging
- Intermittent (tapping) AFM

Chemical Properties

- Chemical Force Microscopy with Functionalized Tip
- Electrochemical Microscopy (EC-STM and EC-AFM)

Thermal Properties

- Scanning Thermal Microscopy (SThM)

Electrical Properties

- Conductive AFM
- I-V Spectroscopy
- Scanning Kelvin Probe Microscopy (SKPM/KPM)
- SKPM with High Voltage
- Scanning Capacitance Microscopy (SCM)
- Scanning Spreading-Resistance Microscopy (SSRM)
- Scanning Tunneling Microscopy (STM)
- Scanning Tunneling Spectroscopy (STS)
- Time-Resolved Photo Current Mapping (Tr-PCM)

Optical Properties

- Tip-Enhanced Raman Spectroscopy (TERS)
- Time-Resolved Photo Current Mapping (Tr-PCM)

Magnetic Properties

- Magnetic Force Microscopy (MFM)
- Tunable MFM

Dielectric/Piezoelectric Properties

- Electric Force Microscopy (EFM)
- Dynamic Contact EFM (DC-EFM)
- Piezoelectric Force Microscopy (PFM)
- PFM with High Voltage

1

Tall Sample 1.5 μm step height

Scan Mode: Non-contact mode, Topography from Z position sensor

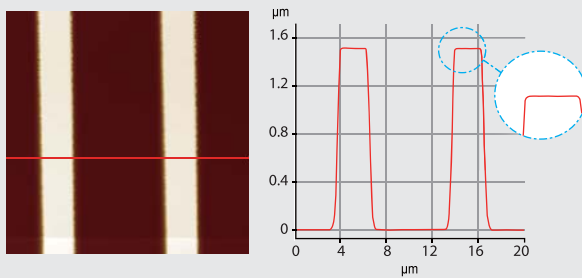

2

Flat Sample Atomic steps of sapphire wafer

0.3 nm step height, Scan Mode: Non-contact mode, Topography from Z position sensor

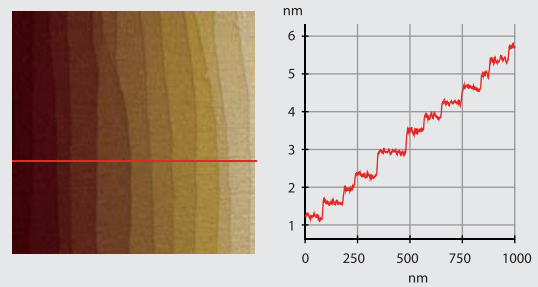

3

Hard Sample Tungsten film

Scan Mode: Non-contact mode, Topography from Z position sensor

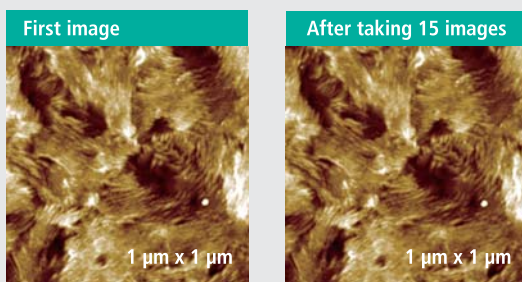

4

Soft Sample Collagen fibril

Scan Mode: Non-contact mode, Topography from Z position sensor

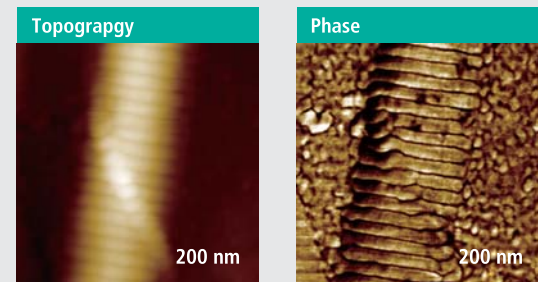

Options

Mechanical Properties

- Force Modulation Microscopy (FMM)
- Nanoindentation
- Nanolithography
- Nanolithography with High Voltage
- Nanomanipulation
- Piezoelectric Force Microscopy (PFM)

Force Measurement

- Force Distance (F-D) Spectroscopy
- Force Volume Imaging
- Spring Constant Calibration by Thermal Method



Z Scanner Heads

- 15 μm Z Scanner Head
- 30 μm Z Scanner Head
- Wide optical access from the side

XY Scanners

- 10 μm x 10 μm XY Scanner
- 50 μm x 50 μm XY Scanner
- 100 μm x 100 μm XY Scanner

Temperature Control

- Heating & Cooling Stage (0~180 $^{\circ}\text{C}$)
- 250 $^{\circ}\text{C}$ Heating Stage
- 600 $^{\circ}\text{C}$ Heating Stage

Liquid Cells

- Universal Liquid Cell
- Electrochemistry Cell
- Open Liquid Cell

Liquid Probehead

- Designed for imaging in general liquid environment
- Resistant to most buffer solutions including acid
- Contact and Non-contact AFM imaging in liquid

Clip-type Chip Carrier

- Can be used with unmounted cantilever
- Tip bias function available for Conductive AFM and EFM
- Tip bias range: -10 V ~ 10 V

Magnetic Field Generator

- Applies external magnetic field parallel to sample surface
- Tunable magnetic field
- Range: -300 ~ 300 gauss
- Composed of pure iron core & two solenoid coils

Park NX10

Specification

| | | | |
|----------------------|--|--|---|
| Scanner | XY scanner Single module flexure XY-scanner with closed-loop control Scan range: 50 μm \times 50 μm (optional 10 μm \times 10 μm or 100 μm \times 100 μm) Resolution: 0.05 nm Position detector noise: < 0.25 nm (bandwidth: 1 kHz) Out-of-plane motion: < 2 nm (over 40 μm scan) | Z scanner Guided high-force flexure scanner Scan range: 15 μm (optional 30 μm) Resolution: 0.015 nm Position detector noise: 0.03 nm (bandwidth: 1 kHz) Resonant frequency: > 9 kHz (typically 10.5 kHz) Topography noise: < 0.03 nm (0.02 nm typical) | |
| Vision | Direct on-axis vision of sample surface and cantilever Field-of-view: 480 \times 360 μm (with 10 \times objective lens) CCD: 1 Mpixel (pixel resolution: 0.4 μm) | Objective lens 10 \times (0.21NA) ultra-long working distance lens (1 μm resolution) 20 \times (0.42 NA) high-resolution, long working distance lens (0.6 μm resolution) | |
| Electronics | Signal processing ADC: 18 channels 4 high-speed ADC channels (64 MSPS) 24-bit ADCs for X, Y, and Z scanner position sensor DAC: 12 channels 2 high-speed DAC channels (64 MSPS) 20-bit DACs for X, Y, and Z scanner positioning Maximum data size: 4096 \times 4096 pixels | Integrated functions 3 channels of flexible digital lock-in amplifier Spring constant calibration (Thermal method, optional) Digital Q control | External signal access 20 embedded signal input/output ports 5 TTL outputs: EOF, EOL, EOP, Modulation, and AC bias |
| Options/Modes | Standard Imaging <ul style="list-style-type: none"> • True Non-Contact AFM • Basic Contact AFM • Lateral Force Microscopy (LFM) • Phase Imaging • Intermittent (tapping) AFM | Chemical Properties <ul style="list-style-type: none"> • Chemical Force Microscopy with Functionalized Tip • Electrochemical Microscopy (EC-STM and EC-AFM) | Dielectric/Piezoelectric Properties <ul style="list-style-type: none"> • Electric Force Microscopy (EFM) • Dynamic Contact EFM (DC-EFM) • Piezoelectric Force Microscopy (PFM) • PFM with High Voltage |
| | Force Measurement <ul style="list-style-type: none"> • Force Distance (F-D) Spectroscopy • Force Volume Imaging | Magnetic Properties <ul style="list-style-type: none"> • Magnetic Force Microscopy (MFM) • Tunable MFM | Optical Properties <ul style="list-style-type: none"> • Tip-Enhanced Raman Spectroscopy (TERS) • Time-Resolved Photo Current Mapping (Tr-PCM) |
| | Electrical Properties <ul style="list-style-type: none"> • Conductive AFM • I-V Spectroscopy • Scanning Kelvin Probe Microscopy (SKPM/KPM) • SKPM with High Voltage • Scanning Capacitance Microscopy (SCM) • Scanning Spreading-Resistance Microscopy (SSRM) • Scanning Tunneling Microscopy (STM) • Scanning Tunneling Spectroscopy (STS) • Time-Resolved Photo Current Mapping (Tr-PCM) | Mechanical Properties <ul style="list-style-type: none"> • Force Modulation Microscopy (FMM) • Nanoindentation • Nanolithography • Nanolithography with High Voltage • Nanomanipulation • Piezoelectric Force Microscopy (PFM) | Thermal Properties <ul style="list-style-type: none"> • Scanning Thermal Microscopy (SThM) |

Stage

Sample size: up to 50 mm x 50 mm, up to 20 mm thickness
Sample weight: up to 500 g
XY stage travel: 20 mm x 20 mm
Z stage travel: 22 mm
Focus stage travel: 15 mm

Software

NXP

Dedicated system control and data acquisition software
Adjusting feedback parameters in real time
Script-level control through external programs (optional)

NXI

AFM data analysis software

Accessories

Electrochemistry Cell
Universal Liquid Cell with Temperature Control
Sample Stages with Temperature Control
Magnetic Field Generator

Dimensions in mm

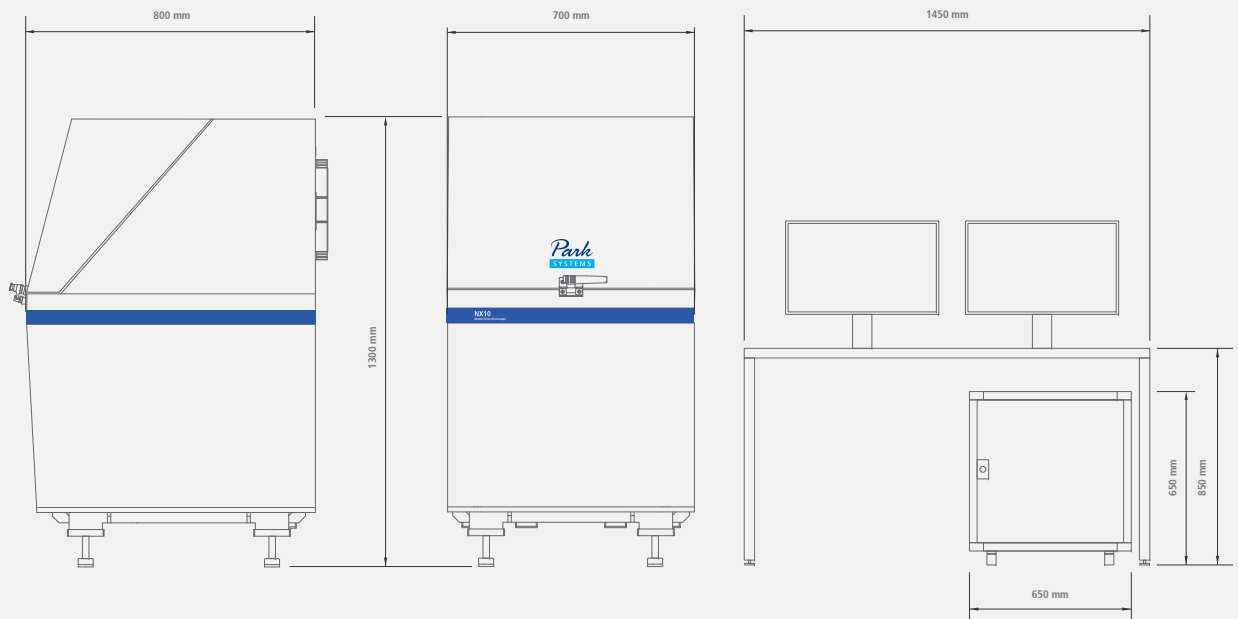
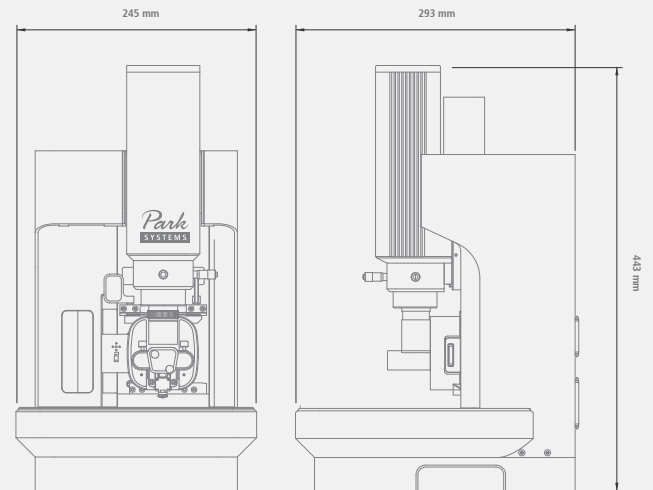

Park Systems

Dedicated to producing the most accurate and easiest to use AFMs

The global headquarters is located at
Korean Advanced Nanotechnology Center (KANC) in Suwon, Korea.



More than a quarter century ago, the foundations for Park Systems were laid at Stanford University where Dr. Sang-il Park, the founder of Park Systems worked as an integral part of the group that first developed AFM technology. After perfecting the technology, he then went on to create the first commercial AFM and later Park Systems was born.

Park Systems strives everyday to live up to the innovative spirit of its beginnings. Throughout our long history, we have honored our commitment to providing the most accurate and yet very easy to use AFMs, with revolutionary features like True Non-Contact™ mode, and many automated software tools. We are not simply content to rest on our past success. All of our products are designed with same care and creativity that went into our first, allowing you to focus on getting results without worrying about the integrity of your tools.



www.parkAFM.com

HEADQUARTERS

GLOBAL HEADQUARTERS: +82-31-546-6800
AMERICAS HEADQUARTERS: +1-408-986-1110
JAPAN HEADQUARTERS: +81-3-3219-1001
SE ASIA HEADQUARTERS: +65-6634-7470

OCEANIA

Australia and New Zealand: +61-2-9319-0122

ASIA

China: +86-10-6401-0651
India: +91-40-655-88-501
Indonesia: +62-21-5698-2988
Malaysia: +603-8065-3889
Philippines: +632-239-5414
Saudi Arabia: +966-2-640-5846
Taiwan: +886-2-8227-3456
Thailand: +662-668-2436
UAE: +971-4-339-2603
Vietnam: +844-3556-7371

EUROPE

France: +33-1-6953-8023
Germany: +49-6103-30098-0
Italy: +39-02-9009-3082
Israel: +972-3-923-9666
Switzerland: +41-22-788-9186
Romania: +40-21-313-5655
Russia: +7 (495) 22-11-208
Spain and Portugal: +34-902-244-343
Turkey: +90-312-236-42-0708
UK and Ireland: +44(0)1372-378-822
Benelux, Scandinavia, and Baltics: +31-184-64-0000

AMERICAS

USA: +1-408-986-1110
Canada: +1-888-641-0209
Brazil: +55-11-4178-7070
Colombia: +57-347-0060
Ecuador: +593-2-284-5287

