



Leica DM300 User Manual

Congratulations!

Congratulations on purchasing the Leica DM300 Compound Microscope. This model's exclusive design features and full range of accessories make it a truly versatile, high quality-instrument.

Though the reliability and robustness of Leica microscopes is already practically proverbial, they still require a certain degree of care and attention. Therefore, we recommend that you read this User Manual. It contains all the information you need regarding operation, safety and maintenance. Simply observing a few guidelines will ensure that even after years of intensive use, your microscope will continue to work as smoothly and reliably as on the very first day.

We wish you the best of success in your work!

Contents

Important Notes

Symbols Used in this User Manual	5
Important Safety Notes	6
Instructions for Use	8
Health risks and dangers of use	10
Information for the Person Responsible for the Instrument	11
Accessories, Maintenance and Repair	12
Electrical Data and Ambient Conditions	13

Assembling the Leica DM300

Unpacking	15
Identifying your Tube	16
Mounting the binocular tube	17
Installing the Monocular Tube	18
Removing and Inserting Objectives	19
Installing the Mirror (optional)	21
Installing the Polarizer Kit (optional)	22

Using the Leica DM300

Switching on the Microscope	24
Selecting an Objective	25
Preparing for Viewing	26
Focusing	27
Adjusting the Binocular Tubes	28
Adjusting the Eyecups	30
Oil Immersion Technique	31

Care of the Microscope

Maintenance instructions	34
General maintenance	35

Dimensions

Dimensions (all dimensions in mm, DM100 and DM300 identical)	38
--	----



Important Notes

Symbols Used in this User Manual

Warning! Safety hazard!



This symbol indicates especially important information that is mandatory to read and observe.

Failure to comply can cause the following:

- Hazards to personnel.
- Instrument malfunctions and damage.

Warning of hazardous electrical Voltage



This symbol indicates information that must be read and observed.

Failure to comply can cause the following:

- Hazards to personnel.
- Instrument malfunctions and damage.

Important Information



This symbol indicates additional information or explanations that are intended to provide clarity.

Important Safety Notes

 Before installing, operating or using the instrument, it is mandatory to read this User Manual. In particular, please follow all safety instructions.

 The instruments and accessories described in this User Manual have been tested for safety and potential hazards.

Original Condition

To maintain the unit in its original condition and to ensure safe operation, the user must follow the instructions and warnings contained in this User Manual.

Non-intended Use

 Using the instrument in any way other than that described in this User Manual may result in personal injury or damage to property. Doing so can impair the functions of the protective measures provided.

 The responsible Leica affiliate must be consulted whenever the instrument is altered, modified or used in conjunction with non-Leica components that are outside of the scope of this User Manual! Unauthorized alterations to the instrument or noncompliant use shall void all rights to any warranty claims.

"Safety Concept" Brochure

The "Safety Concept" brochure contains additional safety information regarding service work, requirements and the handling of the microscope, the electrical and other accessories as well as general safety instructions.



Important Safety Notes (continued)

Legal Regulations

Adhere to general and local regulations relating to accident prevention and environmental protection.

EC Declaration of Conformity

Electrically operated accessories are constructed based on the state of the art of technology and are provided with an EC Declaration of Conformity.

Disconnecting from the Power Supply



Always position the Leica DM300 so that you can disconnect it from the power supply at any time. The power cable must remain accessible at all times, because the power cable is intended as a power disconnect device.

Plug



Never install any other plug (NEMA 5-15P) or unscrew any mechanical components unless expressly instructed to do so in the instructions.

Instructions for Use

This User Manual describes the Leica DM300 and includes important instructions related to operating safety, maintenance and accessories.

Your Leica DM300 includes an interactive CD-ROM with all relevant User Manuals in additional languages. Keep it in a safe place, and readily accessible to the user. You can also download User Manuals and updates from our website at www.leica-microsystems.com.

Intended Use

The Leica DM300 is an optical instrument for improving the visibility of objects through magnification and illumination. It is used for observing.

Place of Use

The Leica DM300 microscope may be used only in closed rooms and must be placed on a solid surface.

The Leica DM300 can be used at +10 °C to +40 °C. Protect the microscope from oil, chemicals and extreme humidity. If it is used outdoors, the microscope must be protected from dust and moisture. Never use electrical instruments outdoors and place them at least 10 cm away from the wall and from flammable substances.

Avoid large temperature fluctuations, direct sunlight and vibrations. These conditions can distort measurements and micrographic images.



In warm and warm-damp climatic zones, the individual components require special care in order to prevent the build-up of fungus.

Instructions for Use (continued)

Accessories from third-party Suppliers

You can combine individual system articles with articles from external suppliers. Please read the User Manual and the safety instructions from the supplier.

Integration in third-party products

When installing Leica products into third-party products, the manufacturer of the complete system or its dealer is responsible for following all applicable safety instructions, laws and guidelines.

Transport

If at all possible, use the original packaging for shipping or transporting individual modules.

In order to prevent damage from vibrations, all moving parts that (according to the User Manual) can be assembled and disassembled by the customer should be packed separately.

Disposal

Disposal must comply with locally applicable laws and regulations.

Health Risks and Dangers of Use

Health Risks



Workplaces with microscopes facilitate and improve the viewing task, but they also impose high demands on the eyes and hand muscles of the user. Depending on the duration of uninterrupted work at such a workplace, impaired vision and problems with the musculoskeletal system may occur. For this reason, appropriate measures for reduction of the workload must be taken:

- Optimum workplace layout
- Frequent changes of activity
- Thorough training of the personnel, giving consideration to ergonomic and organizational aspects

The ergonomic optical design and construction of the Leica microscopes are intended to reduce the exertion of the user to a minimum.

Danger of Infection



Direct contact with eyepieces can be a potential transmission path for bacterial and viral infections of the eye.



The risk can be minimized by the use of personal eyecups.

Dangers during Use

- The Leica DM300 may be connected to a grounded socket only.
- The Leica DM300 may be used when it is in proper working condition only.

LED Class 1 /LED 1 Laser Product

The illumination meets laser class 1 requirements in accordance with IEC 60825-1 "Safety of Laser devices".

Caution: Hazardous radiation may occur if controls, adjustment jigs, or procedures other than those outlined in this User Manual are used!



Information for the Person Responsible for the Instrument

Information for the Person Responsible for the Instrument

- Ensure that the Leica DM300 is used only by persons qualified to do so.
- Ensure that this User Manual is always available at the place where the microscope is in use.
- Carry out regular inspections to make certain that the authorized users are adhering to safety requirements.
- When instructing new users, do so thoroughly and explain the meanings of the warning signs and messages.
- Allocate responsibilities for commissioning, operation and maintenance. Monitor compliance with this.
- Do not use the Leica DM300 unless it is in perfect condition.
- Inform your Leica representative or Leica Microsystems (Schweiz) AG, Industry Division, 9435 Heerbrugg, Switzerland, immediately of any product defect that could potentially cause injury or harm.
- If you use accessories from other manufacturers with the microscope, make sure that these manufacturers confirm that the combination is safe to use. Follow the instructions in the User Manual for those accessories.
- Modifications to or service on the microscope may be carried out only by technicians who are explicitly authorized by Leica to do so.
- Only original Leica replacement parts may be used in servicing the product.
- After service work or technical modifications, the device must be readjusted in accordance with our technical specifications.
- If the unit is modified or serviced by unauthorized persons, is improperly maintained (as long as maintenance was not carried out by Leica Microsystems), or is handled improperly, Leica Microsystems will not accept any liability.
- The building's electrical wiring must comply with the relevant national standard; in other words, we recommend using a current-operated ELCB system (RCB).

Accessories, Maintenance and Repair

Accessories

Only the following accessories may be used with the Leica DM300:

- The Leica Microsystems accessories described in this User Manual.
- Other accessories, provided that these have been expressly approved for use by Leica Microsystems with regard to safety technology.

Maintenance

- The Leica DM300 microscope is basically maintenance-free. To ensure that it always operates safely and reliably, we recommend that you take the precaution of contacting the responsible service organization.
- We recommend concluding a service contract with Leica Microsystems.

Repairs and Service Work

- Only original Leica Microsystems spare parts may be used.
- Before opening the instruments, switch off the power and unplug the power cable.
- Avoid contact with powered electrical circuits, which can lead to injury.

Service Address

In case of problems, please contact us as follows:

Contact address

*Leica Microsystems (Schweiz) AG
Industry Division
Max Schmidheiny Strasse 201
CH-9435 Heerbrugg (Switzerland)*

Electrical Data and Ambient Conditions

Fuse Replacement



Unplug the instrument before changing any fuses. The Leica DM300 has two fuses, which are located behind the power cord receptacle.



Only use fuses of the following type: 5×20 mm, 1.0 A/250 V, high breaking capacity (# 13RFAG30003)

Electrical Data

Input: 100–240 V, 50/60 Hz, 5 W (3 W LED)

General safety notes

This instrument of safety class 1 has been built and tested in accordance with the following safety requirements for electrical equipment for measurement, control, and laboratory use:

EN 61010-1: 2002-08	EN 55011: 2007+A2: 2010-05
EN 61010-2: 2008-06	EN 60825-1: 2008-05
IEC 61010-1: 2010-06	IEC 60825-1: 2007-03
EN 61326-1: 2006-10	LED Class 1
EN 61326-2-6: 2006-10	



In order to maintain this condition and to ensure safe operation, the user must follow the instructions and warnings contained in this instruction manual.

Environment

Temperature for use	+10 °C ... +40 °C
Storage temperature	-20 °C ... +52 °C +50 °F to +104 °F
Manipulation shock	25 mm on 50 mm hard wood
Transport shock (unpacked)	100 g / 6 ms
Transport shock (packed)	800 mm free fall
Transport vibrations (unpacked)	5–200 Hz / 1.5 g
Air pressure during use and storage	500–1060 mBar
Humidity during use and storage	20–90 %
Installation Category II (Overvoltage Category)	
Pollution degree 2	

Assembling the Leica DM300

Unpacking

- Carefully remove the microscope and any components from the packaging.
- Check the components against the planned configuration.
- Optional items such as contrast accessories, camera adapters, cameras, and carrying cases are not shipped as part of the standard equipment. These items are delivered in separate packages.
- Please do not discard any of the packing materials. They should be used for safely storing and transporting the instrument should the need arise.

Identifying your Tube

Identifying your Tube



There are three types of viewing tubes. Identify which viewing tube you have:

Assembly



Installation of the tube is described on [page 17](#) using the binocular "EZTube." Other tubes, however, are installed exactly the same way.

Orientation



All tubes are connected via a dovetail and can be installed in any orientation.



Type 1: Monocular "EZTube"



Type 2: Binocular "EZTube"



Type 3: Open binocular tube

Mounting the Binocular Tube

Tools used

- Allen key



 This User Manual shows the binocular tube. The installation of the monocular tube is shown on the next page. However, handling the microscope is the same for both.

Eyepieces

 The eyepieces are already integrated in the Leica "EZTube" and preset; for this reason, the eyepieces do not require adjustment or assembly.

Assembly

1. Loosen the setscrews at the left and right on the stand using the Allen key provided.



2. Insert the dovetail of the binocular tube into the mount.

3. Turn the tube in the direction you desire.
4. Tighten the set screws on the left and right, without applying too much force.



Installing the Monocular Tube

Tools used

- Allen key



 This User Manual shows the binocular tube from this point on. However, handling the microscope is the same for both. Possible deviations are mentioned on the respective page.

Eyepieces

 The eyepieces are already integrated in the Leica "EZTube" and preset; for this reason, the eyepieces do not require adjustment or assembly.

Assembly

1. Loosen the setscrews (on top of the stand) using the Allen key provided.





2. Insert the dovetail of the monocular tube into the mount.

3. Turn the tube in the direction you desire.
4. Tighten the set screws on the left and right, without applying too much force.



Removing and Inserting Objectives

 The objectives are already installed on the Leica DM300 at delivery. The following description shows how to (un)install the objectives if they have to be removed for cleaning or replaced by other objectives.

 Your Leica DM300 is delivered with objectives with magnification levels 4×, 10× and 40×, possibly also with a 100× objective. Otherwise, this can be retrofitted at any time.

 Always turn the objective nosepiece by its knurled ring. Never turn the objective nosepiece by using an objective as a handle.

Removing Objectives

1. Unscrew the objectives to remove them.



The proper Sequence

 When inserting the objectives, you can begin with any available space on the microscope. Continuation of the sequence, however, has to be selected such that the magnification always increases when turning clockwise:

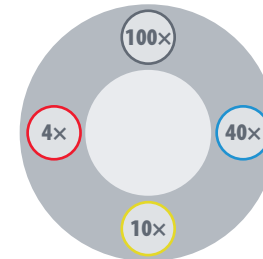

Continued on next page.

Removing and Inserting Objectives (continued)

Inserting Objectives

1. Screw the 4× objective into any available space on the objective nosepiece.



2. Turn the objective nosepiece clockwise one unit.
3. Screw in the next-largest objective.
4. Repeat steps 2 and 3 until all objectives have been installed.

Installing the Mirror (optional)

 The mirror is available as an optional accessory. By means of this, the ambient light can be used for illuminating the sample if no power source is available for the built-in LED illuminator.

 The mirror is equipped with a flat and a concave surface. Try them out to see which side works better.

Installing the Mirror

1. Position the microscope at a well-lit location, for example before a window.
2. Press the mirror onto the mount of the illuminator.



3. Look through the eyepieces and align the mirror so that it works best.

Removing the Mirror

1. Simply pull the mirror out of the holder.

Installing the Polarizer Kit (optional)

 The polarizer kit is not included in the delivery package, but available as an optional accessory.

Assembly

1. If you have already installed the tube, remove it (see [page 17](#)).
2. Place the analyzer with the flat side facing down into the beam path. The two screws have to rest in the two existing holes.
3. Install the tube.
4. Place the polarizer onto the aperture of the illuminator. The handle must come to rest in the aperture with the white arrow pointing upwards.



5. Turn the polarizer to align it. The arrows indicate the current orientation.

Using the Leica DM300

Switching on the Microscope

 For safety reasons, the power cable is grounded via the microscope base. Never use an adapter between the power cable and the power supply; that would render the grounding ineffective.

Work Surface

 Always use the microscope on a hard, stable surface.

Startup Procedure

1. Attach the power cable to the rear side of the microscope.
2. Set the illumination to the lowest setting using the controller on the bottom left of the stand.



3. Switch on the microscope using the toggle switch on the rear side of the stand.



Selecting an Objective

Using the Condenser



The condenser is furnished with an iris diaphragm, which has to be adjusted to match the effective numerical aperture of the individual objectives.

Selecting an Objective

1. Rotate the desired objective over the sample.



2. Rotate the condenser diaphragm below the specimen stage so that the displayed value matches the selected objective.



Preparing for Viewing

Preparation

1. Open the specimen holder using the tension lever.
2. Insert the specimen slide and slowly release the tension lever.
3. Using the X/Y control, position the specimen slide such that a part of the specimen is under the objective used.



Focusing

Focusing

1. Use the knurled ring to rotate the objective nosepiece in such a way that the objective with the lowest magnification level is turned into the working position.



2. Move the specimen stage upwards as far as it will go using the coarse adjustment knob.



3. Look into the eyepieces and adjust the illumination to a comfortable intensity.
4. Bring the specimen into focus using the fine adjustment knob.



Adjusting the Binocular Tubes

1. Adjust the tubes to your interpupillary distance. Fold or unfold the eyetubes to decrease or increase the distance between the eyepieces until you see one illuminated circle.

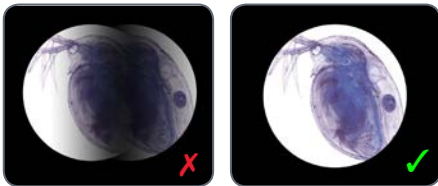

i The viewing tubes maintain a constant tube length for all interpupillary settings. This means that a change of interpupillary distance does not affect parfocality, magnification, or calibrations that depend on magnification.

Leica EZ tubes

If you are using a Leica EZ viewing tube, which already has the eyepieces integrated with the eyetubes, no additional adjustments are necessary. Be sure you are wearing your eyeglasses or contact lenses.

Open Binocular Tube

If you are using an open standard tube, you need to make some adjustments.

1. Set the focusing eyetube (left side) to "0".



Continued on next page

Adjusting the Binocular Tubes (continued)

 If you are comfortable wearing your corrective lenses (contact lenses or eyeglasses) for microscope viewing, leave them on and your adjustments will be minimal.

2. Bring the specimen into focus using 10× magnification and the fine adjustment knob while looking through only the right eyepiece. To help focus, cover or close your left eye.
3. Now look with your left eye through the left eyetube (focusing eyepiece). Now focus using the focus function of the eyetube.

 When doing so, do not change the height of the specimen stage.

4. Rotate the knurled ring on the left eyetube, until the specimen is sharply focused for the left eye. This corrects for any vision differences between your right eye and left eye.

5. Now, switch to an objective with a higher magnification level (no oil objective) and bring the specimen into focus while looking through the eyepieces with both eyes.

 The depth of field is lower for higher magnification levels. Thus, you will notice that if you switch to low magnification after bringing the microscope into focus with great magnification, a minor adjustment of the fine focus may be required. Continue with the "Oil immersion" section on [page 31](#).

Adjusting the Eyecups

 If you wear eyeglasses for microscope viewing, keep the rubber eyecups folded down. If you do not wear eyeglasses, you may find it useful to unfold the rubber eyecups in order to help block out ambient room light.



Potential Sources of Infection



Direct contact with eyepieces is a potential transmission method for bacterial and viral infections of the eye. The risk can be minimized by the use of individual eyecups. Eyecups can be ordered separately. Please contact your Leica partner.

Oil Immersion Technique

Oil Immersion Technique

1. Search for the area on the specimen slide that you want to study.
2. Move the specimen stage down to the lowest position using the coarse adjustment knob.



3. Add a drop of immersion oil from Leica to the area of the specimen slide you are studying.



4. Rotate the 100× objective to the working position.



5. Slowly move the specimen stage upwards using the coarse adjustment knob until the oil drop on the slide comes into direct contact with the lens of the oil immersion objective.

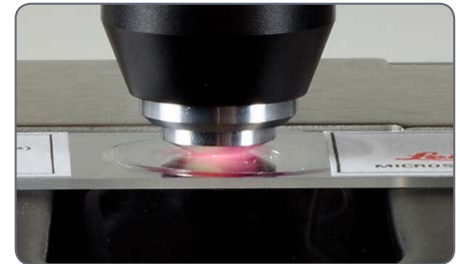

6. Hold the knurled ring on the objective nosepiece and swing the objective back and forth to eliminate air bubbles. Then bring the oil objective into the final position, so that the oil drop is between the front lens of the objective and the specimen slide.

Oil Immersion Technique (continued)

7. Look through the microscope and slowly rotate the fine adjustment knob, so that the specimen stage moves upwards until the specimen is in focus.
8. If you are finished working with the oil immersion objective, clean the front side of the objective, the specimen slide, and all other surfaces that have come into contact with the oil, following the instructions in the "Care of the Microscope" section on [page 33](#).



Care of the Microscope

Maintenance instructions

General Notes

- Protect the microscope from moisture, fumes and acids and from alkaline, caustic and corrosive materials. Do not store chemicals in the vicinity.
- Protect the microscope from oil and grease. Never grease or oil mechanical parts or sliding surfaces.
- Follow the instructions of the disinfectant manufacturer.
- We recommend concluding a service contract with Leica Service.

Cleaning coated Parts and plastic Parts

- Dust and dirt particles should be removed with a soft brush or lint-free cotton cloth.
- Remove coarse debris with a moistened disposable cloth.
- Acetone, xylene or nitro-containing thinners must NOT be used.
- Never use chemicals to clean colored surfaces or accessories with rubberized parts. This could damage the surfaces, and specimens could be contaminated by abraded particles.

General Maintenance

General



Always use both hands to carry the microscope.



- Keep all optical components clean. Cleanliness is important for maintaining good optical performance.
- When the microscope is not in use, it should always be put away with protection against dust.
- If any optical surface becomes coated with dust or dirt, clean the surface by blowing it off with a syringe or brushing it off with a camel hair brush before attempting to wipe the surface clean.
- Optical surfaces should be cleaned using a lint-free cloth with a commercially available glass cleaner.
- Use solvent only very sparingly, so that it does not flow out over the lens. No part of the microscope is quite so vulnerable to collecting dirt, dust, and oil as the front lens of the objective. Whenever you encounter lack of contrast, cloudiness or poor definition, carefully check the condition of the front lens with a magnifier.

General Maintenance (continued)

- The lower magnification objectives have fairly large front lenses and can be cleaned with a cloth or lens tissue wrapped around a finger and moistened with window cleaner.
- Cleaning 40× and 100× objectives requires more care. To attain the typical flatness for objectives with higher magnification, the objective has a small concave front lens with a very small radius and slight curvature. The surface of this front lens can be readily cleaned with a toothpick covered with a cotton tip, or with a small cotton swab. Wipe the front lens lightly without applying undue force or scrubbing action. Make sure that the cotton tip contacts the concave lens surface. Check the objective with a magnifier after cleaning.

Illumination

- The Leica DM300 uses an LED illuminator. Therefore, no lamp changing is required for the entire life of the microscope.

Dimensions

Dimensions (all Dimensions in mm, DM100 and DM300 identical)

- side view with binocular tube

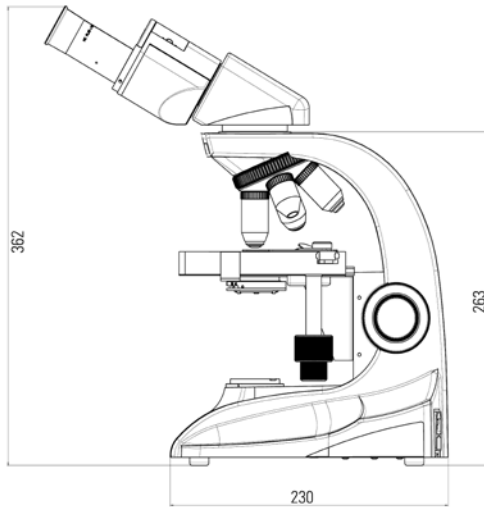

- front view with binocular tube

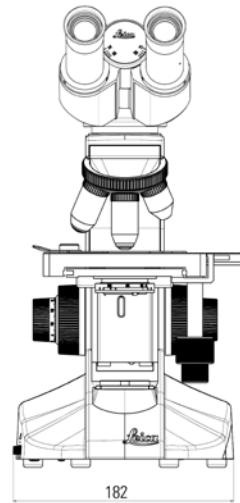

- side view with binocular tube 180° rotated for storage

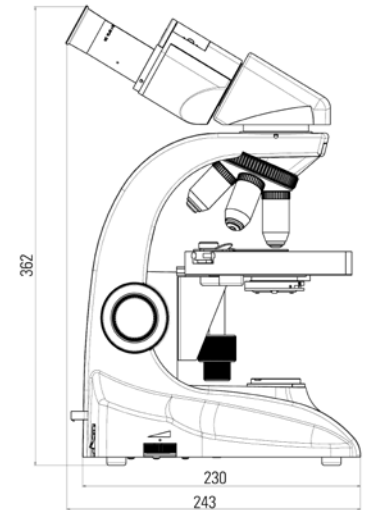

Dimensions (all Dimensions in mm, DM100 and DM300 identical)

- side view with monocular tube

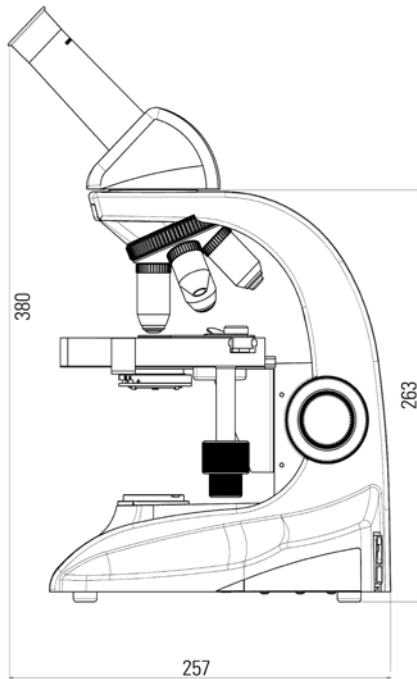

- front view with monocular tube

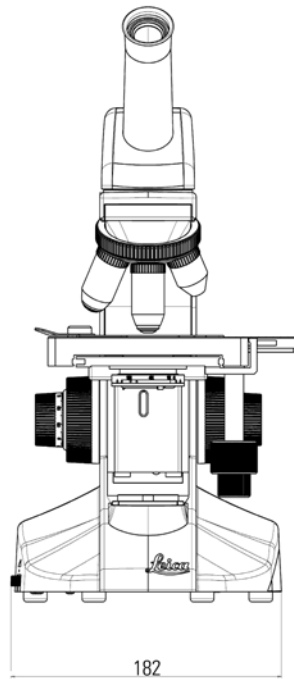

- side view with monocular tube 180° rotated for storage

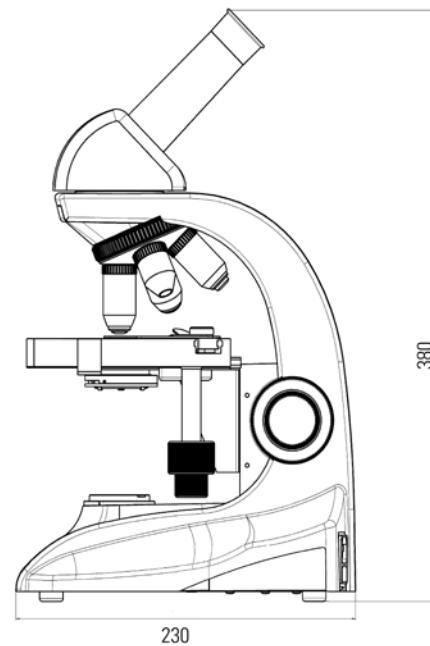

The productive cooperative effort "with the user, for the user" has always been the basis for the innovative strength of Leica Microsystems. On this, we have developed our five corporate values:

pioneering, high-end quality, team spirit, dedication to science, and continuous improvement. We call making these values reality **Living up to Life.**

INDUSTRY DIVISION

The Leica Microsystems Industry Division's focus is to support customers' pursuit of the highest quality end result by providing the best and most innovative imaging systems for their needs to see, measure, and analyze microstructures. Its solutions are used in routine and research industrial applications, in materials science and quality control, in forensic science investigations, and educational applications.

Leica Microsystems – an international company with an experienced worldwide customer service network.

Internationally active	Phone	Fax
Australia · North Ryde	+61 2 8870 3500	2 9878 1055
Belgium · Diegem	+32 2 790 98 50	2 790 98 68
Denmark · Ballerup	+45 4454 0101	4454 0111
Germany · Wetzlar	+49 64 41 29 40 00	64 41 29 41 55
England · Milton Keynes	+44 800 298 2344	1908 246312
France · Nanterre Cedex	+33 811 000 664	1 56 05 23 23
Italy · Milan	+39 02 574 861	02 574 03392
Japan · Tokyo	+81 3 5421 2800	3 5421 2896
Canada · Concord/Ontario	+1 800 248 0123	847 405 0164
Korea · Seoul	+82 2 514 65 43	2 514 65 48
The Netherlands · Rijswijk	+31 70 4132 100	70 4132 109
Austria · Vienna	+43 1 486 80 50 0	1 486 80 50 30
Portugal · Lisbon	+351 21 388 9112	21 385 4668
Sweden · Kista	+46 8 625 45 45	8 625 45 10
Switzerland · Heerbrugg	+41 71 726 34 34	71 726 34 44
Singapore	+65 6779 7823	6773 0628
Spain · Barcelona	+34 93 494 95 30	93 494 95 32
USA · Buffalo Grove/Illinois	+1 800 248 0123	847 405 0164
People's Republic of China · Hong Kong	+852 2564 6699	2564 4163
· Shanghai	+86 21 6387 6606	21 6387 6698

13IDE11060EN · Copyright © by Leica Microsystems (Schweiz) AG, CH-9435 Heerbrugg, 2014.
Subject to modifications. LEICA and the Leica Logo are registered trademarks of
Leica Microsystems IR GmbH.