

S-Ram, Confocal Micro Raman System

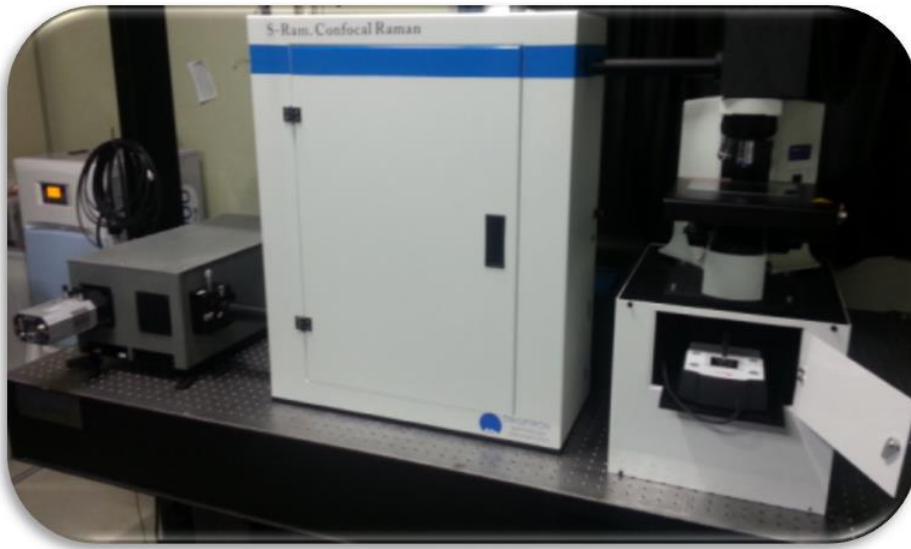

Measurement

- Confocal Micro Raman/Photoluminescence
- Room Temp Macro/Micro Photo luminescence Excitation(Absorption) / Mapping
- Low Temp Micro Raman/Photoluminescence/EL
- Fluorescence life time measurement
- Room Temp Thickness
- AFM-Raman, TERS(Preliminary)

Application

- Carbon material(CNT, Graphene) Surface and subsurface analyze
- Single molecule detection
- Thin film solar cell crystallization(a-Si, uc-Si)
- Stress evaluation of Silicon(Si)
- Semiconductor surface structure
- Profiling of polymer layers
- Air pollution analyze
- Flexible LCD with CNT clear electrode
- Development of Bio sensor thro Au ball

Feature

- Laser combiner : support up to 3 lasers, additional external fiber connection
 - High spectral & spectral resolution
 - Macro Sample chamber capabilities for Fluorescence, Transmittance & Transmittance
 - Real confocal module down to few micrometer(optional variable type)
 - Fiber adapter box for Macro sample chamber or Raman probe
 - Sub-micron confocal Raman imaging
 - Heating and cooling stage(down to 4K)
 - Automation(control input power, wavelength , filter polarizer orientation, pinhole size, grating & detector)
 - Free space & Fiber optic connection to Micro/Macro sample chamber & Spectrograph set.
 - Notch filter module (stokes & anti-stokes detection)
 - XY mapping down to 0.1 um step
 - Z axis signal profiling and Auto focusing
 - Combination with PL/PLE & TCSPC
-

System laser

Parameter				
Application	PL/Raman	PL/Raman	PL/Raman	PL/Raman
Wavelength (nm)	325	532	632.8	785
Spectral line width(nm)	-	0.00001	257MHz	100MHz
Output power	30mw	50mw	>18	>100mw
Mode	TEM00	TEM00(SLM)	TEM00(SLM)	TEM00(SLM)
Operating mode	CW	CW	CW	CW
Beam dia.(mm)	<1.2	<1.2	<1.0	<0.7
Beam divergence(mrad)	<0.5	<1.2	<1.0	<2.5
Mode Quality(M2)	-	<1.2	-	-
Polarization	Linear(>500:1)	Linear(100:1)	Linear(>500:1)	
Power stability(%)	<+/-2.0(4hr)	3 (over2hr)	<5(8hr)	+/-1
Operating Temp.	10~60C	10~35C	10~60C	15~45C
Life time(Hr)	2,000	10,000	-	-
Power supply	100~240V, 50/60Hz	85~240V 50/60Hz		110~220V
Fiber optic Option	OK	OK	OK	OK

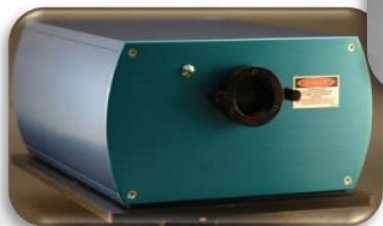

System Chamber

Parameter	
Application	Raman /PL /Mapping /LT PL-Raman/ Lifetime /measurement
Sample area	Large sample area for Low temp Macro PL(E) and Room temp PL mapping and thickness measurement
Sample stage	XY axis(max.) : 50 mm x75 mm Repeatability : < 1 um Resolution(min.) : 0.05 um(min.) 0.1 um(typical) Z axis Travel : 100 um +/- 15% Resolution (close-loop) : 10 nm Sample holder for solids/powder samples
Optics Spectral range	200 ~5,000 nm
Vision system	For Sample Image & Input beam position monitoring Max. 1600x digital image CCD camera with IEEE 1394 interface
Automation	Software controlled laser rejection filter switching Software controlled Variable ND filter set to adjust input beam power Transmittance : 0.00001% ~ 100% (up to 9 different power level & 33 levels available on request)
Objective lens	10X,20X, 50X & 100X long working plan lenses
Beam spot size	<1 um @ 100X objective
Raman shift range	Raman shift range For 325 nm laser 305 cm ⁻¹ ~ 4000cm ⁻¹ For 514.5 nm laser 80 cm ⁻¹ ~ 4,000cm ⁻¹ For 785 nm laser 63 cm ⁻¹ ~ 2,500cm ⁻¹
White light source	Sample image and beam path alignment with back scattered light
Option	Upgradable for variable application without any change of Hardware and controlled through the same platform, If Requirement arises in future True confocal module. Additional wide range of detector system.(UV-NIR) Low temp condition study (down to 4K ~ 600K) Additional macro sample chamber for PLE, T/R and Life Time measurement High resolution spectrometer available(up to 0.012 nm)

Low temp condition

Parameter	
Application	TDIPL(Temperature Dependant PL) IQE(Internal Quantum Efficiency)
10K Cryocooler	Closed Cycle Cryocooler
Vacuum shroud	Welded stainless steel for high vacuum environment in sample compartment
Temperature range	10 ~ 325 K
Stability	0.1K
Sample area	36 mm dia. & 39 mm height Maxi sample size to hold : 20 mm dia.
Window	High purity Quartz material 90degree apart window port(4ea)
Cooling capacity	0.4 ~ 0.5 W (10K)
Cooling time	50 min to 20K 70 min to minimum
Noise level	60dBA
Input voltage	208 ~ 230V /50Hz or 190 ~ 210V/60HZ Power usage : 1.2 kW~1.3kW
Typical maintenance time	12,000 hours
Vacuum pump system	Turbo molecule pump system
Head dimension	Overall length : 562 mm Rotational clearance : 200 mm
Compressor dimension	483x434x516 mm(H)
Ambient Temperature	12 ~ 40 C

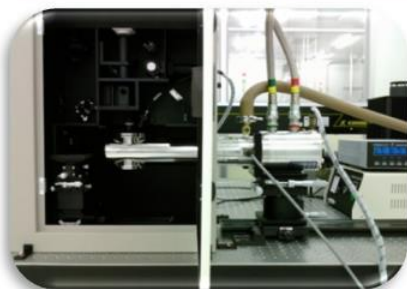

Cryostat system
For 2 inch wafer sample



For microscope



Cryostat head(~4k)

Mapping stage

Parameter	
Application	Transmitted and reflected light , upright microscope
Travel range	76x52 mm
Repeatability	<1 um(bi-directional)
Accuracy	1 um
Resolution	0.05 um(smallest step size)
Orthogonality	<10 arc sec
Motor	2 phase stepper motor
Max. travel speed	120mm/s
Limit switch	Optical light beam
Material	Aluminium
Surface	Anodic coating, black laquered
Dimension	232x226x23(thickness) mm
Warranty	5year

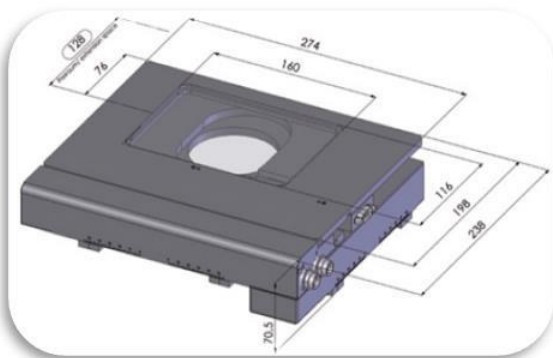

High precision Microscope scanning stage

System Monochromator

Parameter	
Application	Spectrum analyzer , monochromatic light source
Focal length	500 mm
Aperture ratio	f/6.5
Optical design	Czerny-Turner, Imaging spectrograph by Toroidal
Optical port	Adjustable side entrance and two exit slits /port
Mechanical scan range	0~1,200 nm
Operating range	330 nm ~ 2,600 nm
Gratings turret	Triple grating turret controlled by Software With 1200gr/mm 500 nm blz , 1200gr/mm 850 nm blz. 600gr/mm 1600 nm blz gratings Interchangeable grating module(option)
Resolution	0.045 nm
Dispersion	1.7nm/mm
Accuracy	+/-0.1 nm
Repeatability	+/-0.04 nm
Focal plane size	26mm wide × 14mm high
Detector coverage	41nm @ 1200gr/mm grating
Slit	A micrometer controlled adjustable slit assembly for one entrance and two exit ports 0 to 5mm(10micrometer increment/decrement unit)
Interface	RS232 & USB standard
Size/Weight	546(L)×258(W)×224 mm(H)/15Kg

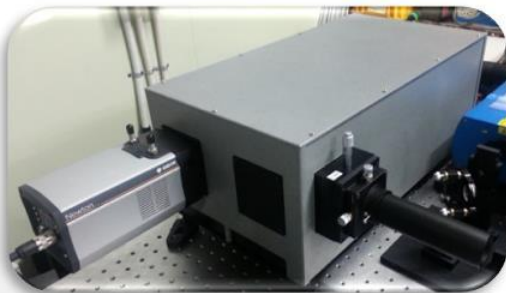

System detector

Parameter			
Application	Photoluminescence, Raman, Reflectance & Transmittance		
Detector type	PMT	IGA(InGaAs)	CCD
Spectral range	185~900 nm	800~1,700 nm	200~1,100 nm(2,200)
Sensing Area	24 mm	3 mm dia	26.6 mm
High voltage	0~800 V(Max1200)	-	-
Cooling system	Non cooled	TE Cooled	TE Cooled
Responsivity (V/W @ pk)	-	$0.9 \times 10^8 / 10^7$	-
Output signal type	Voltage/Curr ent/BNC	Voltage/BNC	USB2.0
Noise		$5 \times 10^6 / 0.5 \times 10^6 (V/Hz)$	$4e-@50kHz$
Operating temperature	50 ~ -30 C	22 ~ -30 C	-100~ 25 C
Response time	2.2ns(anode pulse rise time)	2 u sec(min.)	-
Power requirement	AC110 ~ 220V /1.2 A 50/60Hz	+/-9VDC to +/-15VDC	110~220VAC 50-60Hz



- PDS-1, PMT detector



- Photodiode detector



- CCD detector

Software ; Maple – scan image & spectroscopy

- Spectral mode
 - Set the wavelength range, number of Point/resolution
Integration time(msec), Accumulation etc.
- Real time measurement and spectrum displayed in parallel
Wavelength/Wavenumber(Photoluminescence /Raman), Intensity, FWHM, optional
Thickness
- Sample area Double peak isolation(Focused on shoulder peak or exclude area)
- User defined threshold, Max and Min Values
- Set Step resolution and scanning area
- Automation
 - High speed/High precision XYZ stage control (below 0.1 um)
 - Laser focus calibration : Intelligent auto Z-axis stage calibrates the laser beam
focus(optional)
 - Select proper grating , ent/exit slit of monochromator control , beam diverting mirror
control,
 - Laser beam block to prevent harmful scattering,
 - Motorized filter wheel control according to the input laser line(reject laser and pass
signal to
Detector)
 - Motorized ND filter in front of laser to control the laser power on sample surface
 - Sample and laser beam spot capture for alignment

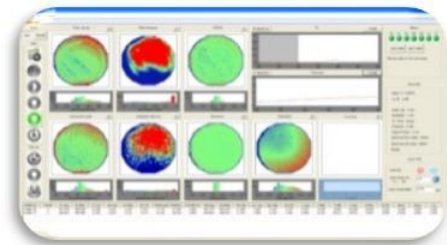
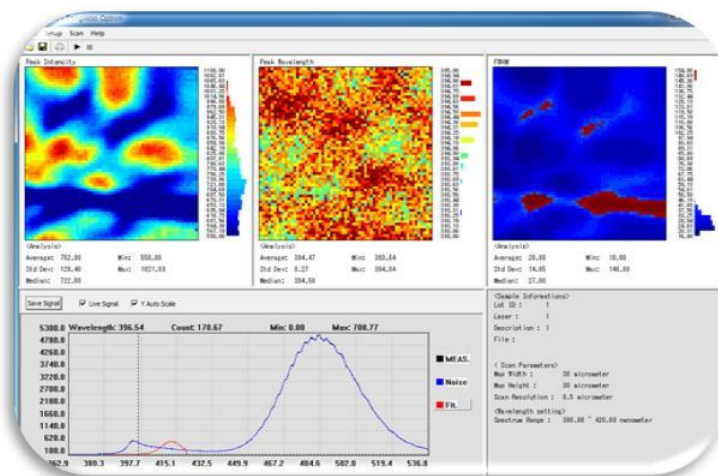

- Maple, operating software window for Maple II, Micro PL mapping system for research
- Maple-I, operating software window for high Speed mapping system for Industry

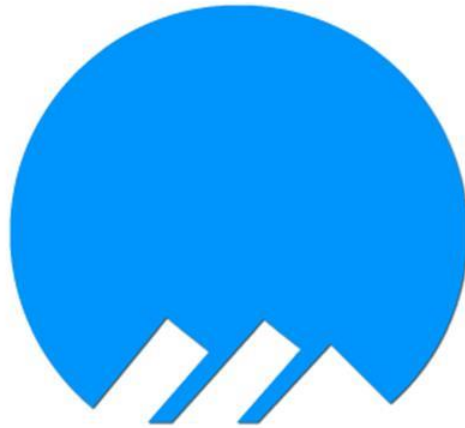

Partner for Spectroscopy

Leading spectroscopy company Since 1989
DongWoo Optron Co., Ltd.
102-8, Hoean-Daero, Opo-Eup, Gwangju-Si,
Gyunggi-Do, South Korea, 464-893
Tel: +82 (0)31-765-0300 Dir. +82 (0)70-4673-4705
Fax: +82 (0)31-765-0222
E-mail: dos@optron.co.kr
<http://www.dwoptron.co.kr>

DongWoo is the company creating new wavelength