



Leica LED2000 / LED2500 User Manual

Contents

General Instructions	
General Instructions	4
Important Safety Notes	5
Symbols Used	6
Safety Instructions	7

Introduction	
Control Elements	11

Assembly	
Installation of Leica LED2000 / LED2500	14
Assembling the Optics Carrier	16

Operation	
Controlling the Illumination	20
Illumination Levels and Brightness	21
The Correct Height for the Arc Illuminator	24
Illumination Types and Results	25

Service	
Care, Maintenance, Contact Persons	30

Specifications	
Technical Data	34
Dimensional Drawings Leica LED2000 / LED2500	35



General Instructions

General Instructions

Safety concept

Before using your Leica stand for the first time, please read the “Safety Concept” brochure included with your instrument. It contains additional information on handling and care.



Use in clean rooms

The Leica LED2000 / LED2500 stand can be used in cleanrooms. The user has to evaluate the final suitability within the required cleanroom class. There is no special certification for specific cleanroom categories or applications.

Cleaning

- Do not use any unsuitable cleaning agents, chemicals or techniques for cleaning.
- Never use chemicals to clean colored surfaces or accessories with rubberized parts. This could damage the surfaces, and specimens could be contaminated by abraded particles.
- In most cases, we can provide special solutions on request. Some products can be modified, and we can offer other accessories for use in clean rooms.

Servicing

- Repairs may only be carried out by Leica Microsystems-trained service technicians. Only original Leica Microsystems spare parts may be used.

Responsibilities of person in charge of instrument

- Ensure that the Leica stand is operated, maintained and repaired by authorized and trained personnel only.

Important Safety Notes

Instructions for use

The Leica LED2000 / LED2500 can be configured in a variety of ways in the Leica product range. You can find information on individual system components on the interactive CD-ROM together with all relevant user manuals in additional languages. Keep it in a safe place, and readily accessible to the user. User manuals and updates are also available for you to download and print from our website www.leica-microsystems.com.

This operating manual describes the special functions of the Leica LED2000 / LED2500 stand and contains important instructions for its operational safety, maintenance, and accessories.

The "Safety Concept" booklet contains additional safety information regarding the service work, requirements and the handling of the stands, accessories and electrical accessories as well as general safety instructions.

You can combine individual system articles with articles from external suppliers (e.g. cold light sources, etc.). Please read the User Manual and the safety instructions from the supplier.

Before installing, operating or using the instruments, read the user manuals listed above. In particular, please follow all safety instructions.

To maintain the unit in its original condition and to ensure safe operation, the user must follow the instructions and warnings contained in these user manuals.

The microscope illumination is in the exempt group (risk group 0) according to EN 62471:2008 when used according to its intended use.



Never look directly into the LED beam of the illumination equipment – either with or without optical instruments – as this increases the risk class. Failure to observe this notice poses a risk of eye damage.

Symbols Used

Warning! Safety hazard!



This symbol indicates especially important information that is mandatory to read and observe.

Failure to comply can cause the following:

- Hazards to personnel
- Functional disturbances or damaged instruments

Warning of hazardous electrical voltage



This symbol indicates information that must be read and observed.

Failure to comply can cause the following:

- Hazards to personnel
- Functional disturbances or damaged instruments

Danger due to hot surface



This symbol warns against touching hot surfaces, e.g. those of light bulbs.

Important information



This symbol indicates additional information or explanations that are intended to provide clarity.

Safety Instructions

Description

- The Leica LED2000 / LED2500 stands are designed for use in Leica S-series stereo-microscopes (S4; S6; S8 Apo); M-series (M50, M60, M80) and DMS-series (DMS300, DMS1000). The integrated power LED illumination ensures optimal lighting conditions.

Intended use

- Refer to "Safety Concept" booklet

Non-intended use

- Refer to "Safety Concept" booklet

Never use the Leica LED2000 / LED2500 stand and its components for IvD / IvF and/or medical applications, since they are not intended for these.

The instruments and accessories described in this User Manual have been tested for safety and potential hazards. The responsible Leica affiliate

must be consulted whenever the instrument is altered, modified or used in conjunction with non-Leica components that are outside of the scope of this manual!

Unauthorized alterations to the instrument or noncompliant use shall void all rights to any warranty claims.

Place of use

- Refer to "Safety Concept" booklet
- Electrical components must be placed at least 10 cm away from the wall and from flammable substances.
- Avoid large temperature fluctuations, direct sunlight and vibrations. These conditions can distort measurements and micrographic images.

- In warm and warm-damp climatic zones, the individual components require special care in order to prevent the build-up of fungus.

Responsibilities of person in charge of instrument

- Refer to "Safety Concept" booklet

Ensure that:

- The Leica LED2000 / LED2500 stand and accessories are operated, maintained and repaired by authorized and trained personnel only.
- All operators have read, understood and observe this User Manual, and particularly the safety regulations.

Safety Instructions (Continued)

Repairs, service work

- Refer to “Safety Concept” booklet
- Only original Leica Microsystems spare parts may be used.
- Before opening the instruments, switch off the power and unplug the power cable.
- Avoid contact with powered electrical circuits, which can lead to injury.

Transport

- Use the original packaging for shipping or transporting the individual modules of the Leica LED2000 / LED2500 and the accessory components.
- In order to prevent damage from vibrations, disassemble all moving parts that (according to the user manual) can be assembled and disassembled by the customer and pack them separately.

Integration in third-party products

- Siehe Booklet “Sicherheitskonzept”

Disposal

- Refer to “Safety Concept” booklet”

Legal regulations

- Refer to “Safety Concept” booklet”

EC Declaration of Conformity

- Refer to “Safety Concept” booklet”

Health risks

Workplaces with microscopes facilitate and improve the viewing task, but they also impose high demands on the eyes and holding muscles of the user. Depending on the duration of uninterrupted work, asthenopia and musculoskeletal problems may occur. For this reason, appropriate measures for reduction of the workload must be taken:

- Optimal arrangement of workplace, work assignments and work flow (changing tasks frequently).
- Thorough training of the personnel, giving consideration to ergonomic and organizational aspects.

The ergonomic design of the Leica LED2000 / LED2500 aims to limit the strain on the user to the lowest possible level.

Safety Instructions (Continued)

Technical safety

To connect the Leica LED2000 / LED2500 to power, use a power cable that meets the power cable specifications in your country. The power socket used has to be equipped with a 16 A or 10 A fuse. Only connect the instrument to a grounded power socket that has been installed according to regulations. The power supply voltage has to correspond to the voltage specified on the identification label. Make sure that the ground connection is neither defective nor interrupted, since otherwise a malfunction poses a risk of fatal injury. Never unplug the power plug with moist or wet hands. There is danger of an electric shock.



Introduction

Control Elements

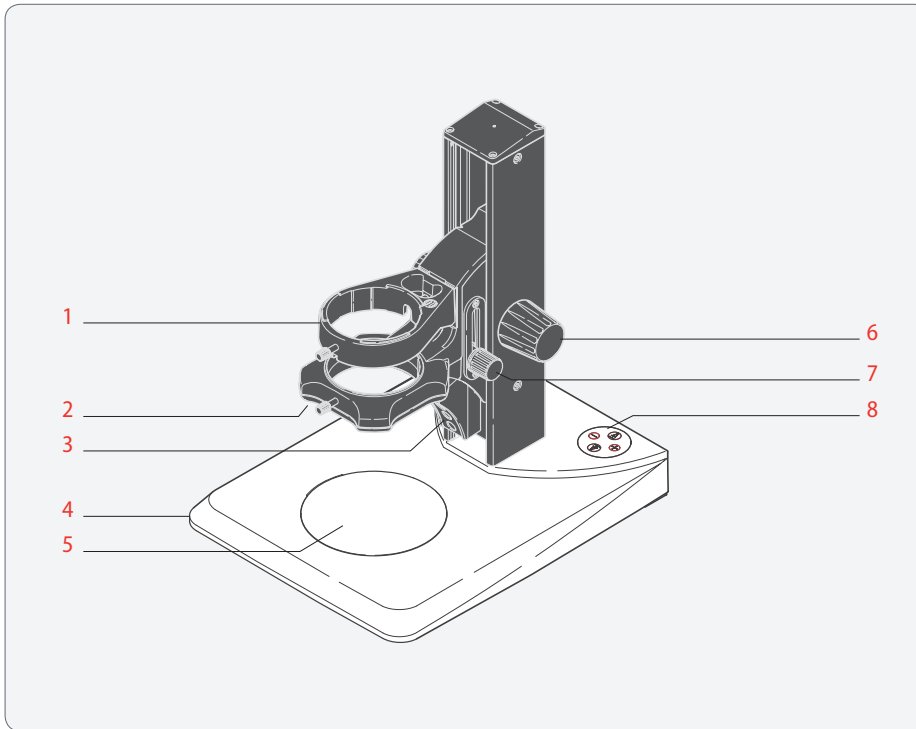

- 1 Adapter for holding the optics carrier
- 2 Integrated ring illuminator with 4 power LEDs
- 3 Movable arc illuminator with 3 power LEDs
- 4 Base
- 5 Stage plate black/white; 120 mm \varnothing (LED2000) or glass insert plate 120 mm \varnothing (LED2500)
- 6 Focusing drive
- 7 Locking screw for the arc illuminator
- 8 Membrane keyboard for selecting the illumination option and brightness adjustment

Control Elements (Continued)

Rear side of the Leica LED2000/ LED2500

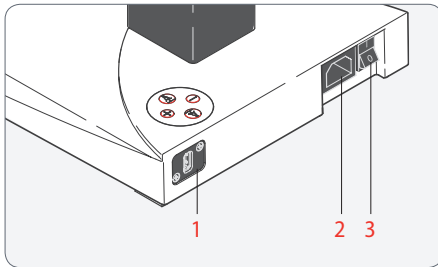

- 1 5 V / 500 mA USB port (e.g. for supplying power to a Leica DMS300 / DMS1000)
- 2 Power socket
- 3 Power switch



The USB port is not suitable for connecting to a computer or other computer systems. Since the USB output has a voltage of 5 V, there is a danger of damage being incurred from improper use.

Assembly

Installation of Leica LED2000 / LED2500

Unpacking the base

The stand is supplied completely assembled.



Unpack the instruments on a sufficiently large, level, non-slip surface.

Connecting to AC power

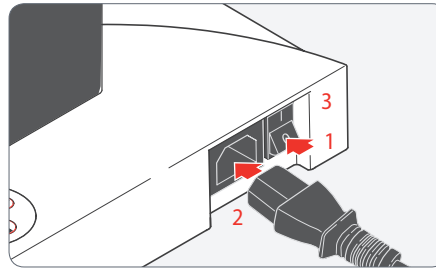

1. Ensure that the power switch on the base is set to "0".
2. Insert the power cable into its socket and connect it to a grounded power outlet.
3. Switch the Leica LED2000 / LED2500 on using the main switch on the rear side of the base.

Installation of Leica LED2000 / LED2500 (Continued)

Inserting the stage plate or glass insert plate

 The Leica LED2000 is supplied with a stage plate (black/white, 120 mm \varnothing). It may be used with the black or white side facing up, depending on the required contrast. For the Leica LED2500, please use the provided glass insert plate.

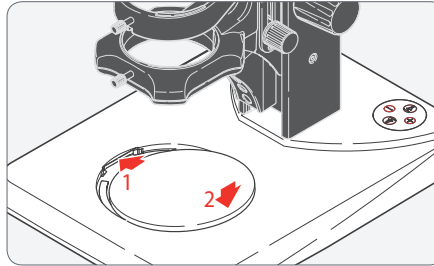

Insert the stage plate by gently pressing against the tension spring.

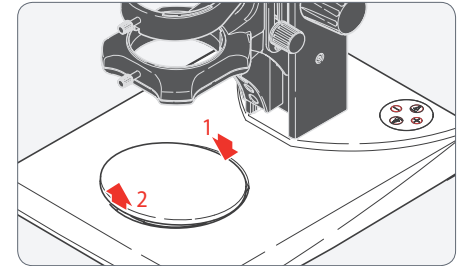

Remove the stage plate by gently pressing on the rear part.

Assembling the Optics Carrier

Adapter position on the LED2000 / LED2500

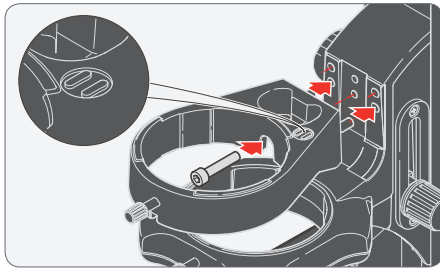

i Installing an optics carrier on the Leica LED2000 / LED2500 stand requires that an adapter be installed at a different height, depending on the specific optics carrier. The marking **II** has to be on the top of the carrier if the carrier is required.

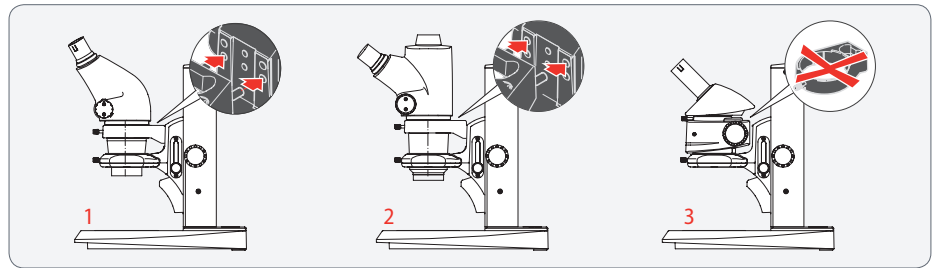

1. For Leica S4 / S6 and Leica M80 instruments, the adapter is fastened in the **lower position**.
2. For Leica S8 APO instruments, the adapter is fastened in the **upper position**.
3. For Leica M50 / M60 and Leica DMS300 / DMS1000 instruments, the Leica LED2000 / LED2500 is used **without an adapter**.

Regulating the Resistance of the Focusing Drive

 The focusing drive is used to set the sharpness by regulating the working distance between the microscope and the product. You can find an overview of the various objectives and their working distances in the Technical Data for the applicable microscopes.

Is the focus movement too loose or too tight? Does the outfit tend to slide downwards? No problem – the resistance can be adjusted to suit the weight of your equipment and personal preferences:

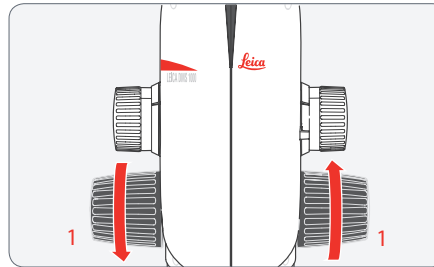

1. Grasp the drive knobs with both hands and turn them towards each other until the desired resistance is reached for focusing.

Safety when focusing



When using the focusing drive, do not insert objects or fingers between the optics carrier and stand. Failure to observe this point can result in damage or injury.

Transporting the Leica LED2000 / LED2500

Mobility was a primary consideration for us in developing the Leica LED2000 / LED2500.

Proper transport

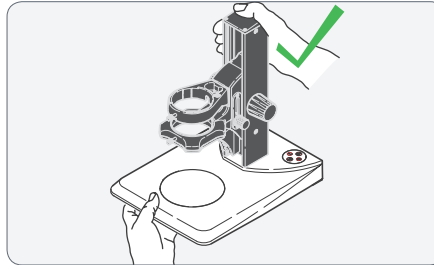



To transport the stand safely:

1. Remove all cables and ensure that the stereomicroscope and all accessories are attached firmly.
2. Use both hands to lift the stand (see figure).

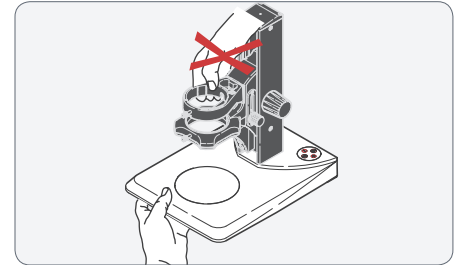
Incorrect transport



 Risk of damage to the microscope or stand.

 Do not lift the stand by the cover of the column.

 Do not lift the stand by the stereomicroscope.

Operation

Controlling the Illumination





Via the power LEDs



The Leica LED2000 and LED2500 stands feature power LEDs. The high-performance LEDs provide uniform illumination at a daylight-like light temperature. At the same time, they use considerably less power and generate considerably less warmth than conventional illumination systems.

The Leica LED2000 uses power LEDs in the ring and arc illuminators. They also provide transmitted illumination in the base of the Leica LED2500.

Switching the illumination on and selecting the illumination type

1. Turn on the power switch on the rear of the Leica LED2000 / LED2500.
2. Press the  button to switch on the illumination.
3. Continue pressing the  button to cycle through the various illumination combinations.
4. Press the  and  buttons to adjust the illumination intensity in 10 steps. To switch the illumination off completely, press the  button or use the power switch.

The Leica LED2000 / LED2500 remembers the last illumination combination, restoring it the next time you switch the instrument on.

The microscope illumination is in the exempt group (risk group 0) according to EN 62471:2008 when used according to its intended use.







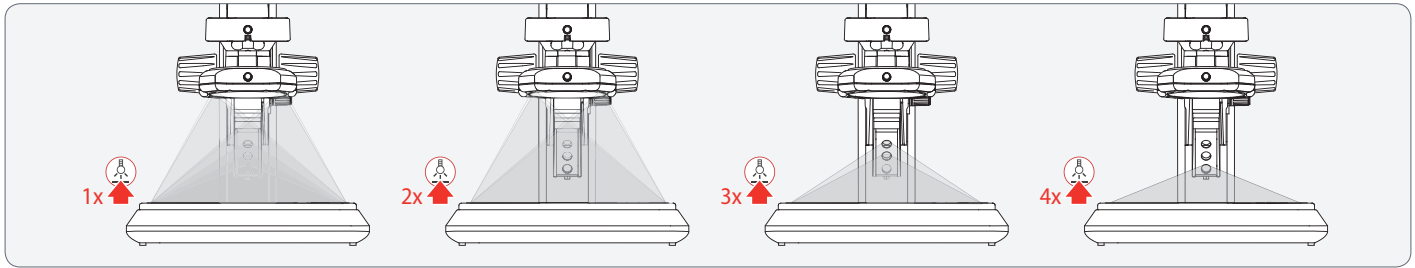

Never look directly into the LED beam of the illumination equipment – either with or without optical instruments – as this increases the risk class. Failure to observe this notice poses a risk of eye damage.

Illumination Levels and Brightness

The illumination combinations



i Each time the  button is pressed, the illumination combination changes in this sequence:

- 1x  everything ON (ring illuminator & arc illuminator)
- 2x  ring illuminator only ON
- 3x  the upper two power LEDs of the arc illuminator ON
- 4x  the lowest power LED of the arc illuminator ON
- 5x  everything OFF

Illumination Levels and Brightness (Continued)

Special features of the Leica LED2500

The brightness of the transmitted light unit cannot be adjusted separately – it is set together with the arc illumination and the ring light. There are three scenarios for transmitted light from the Leica LED2500:



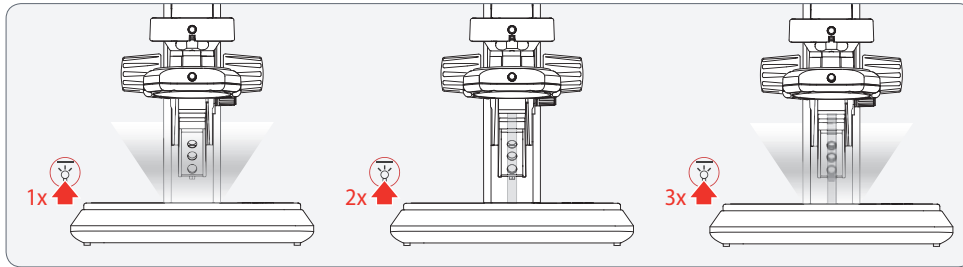

1. A diffuse variant of the transmitted light illumination for generating a large area of uniform transmitted light. This enables effective illumination of large samples that already have a high contrast.
2. Centrally directed transmitted light illumination, which generates a defined contrast. The illumination function is particularly recommended if the sample has low intrinsic contrast. The contrast and brightness in the outer area of the illumination decrease along with this.
3. All LEDs are switched on. This generates the maximum brightness of the transmitted light illumination.

Illumination Levels and Brightness (Continued)

The illumination combinations of the transmitted light unit (LED2500)



i The Leica LED2500 is equipped with a transmitted-light unit that can be turned on and off with the  button.

- 1x  diffuse transmitted light ON (for a large, high-contrast samples requiring uniform illumination)
- 2x  directed, central transmitted light illumination ON (suitable for low-contrast samples; the contrast and brightness decrease in the outer area)
- 3x  combination of diffuse and directed transmitted light illumination (maximum brightness of the transmitted light)
- 4x  transmitted light OFF

The Correct Height for the Arc Illuminator

i Depending on the situation, it is advisable to adjust the height of the arc illumination. To do so, first focus the sample and then optimize the height of the arc illumination until the corresponding result is attained.

Adjusting the arc illuminator

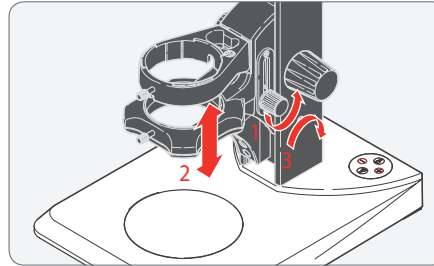

The height of the arc illuminator can be adjusted independently of the focus to ensure the best possible illumination for your requirements.

1. Loosen the screw of the arc illuminator so that the illuminator is free to move.
2. Move the arc illumination up and check the result through the eyepiece of the stereo-microscope.
3. Retighten the screw.

Illumination Types and Results

Take advantage of the options!

The combination of ring light, arc illumination and transmitted light illumination (only Leica LED2500) provides you with a broad range of different illuminations. Take advantage of this flexibility to provide the best possible illumination for your specimens. You will be surprised at how you can improve your results.

We would like to use a few examples to inspire you to find the best kind of illumination for your specific requirements through testing. Depending on the application and specimen, each of the four illumination types provides new information. As there is no such thing as an „ideal illumination setting“, we recommend cycling through the sequences until you find the setting best suited to your specimen.

Feel free to experiment – it’s worth it!

Use the buttons of the Leica LED2000 and LED2500 to change the illumination scenarios and to adjust the brightness.

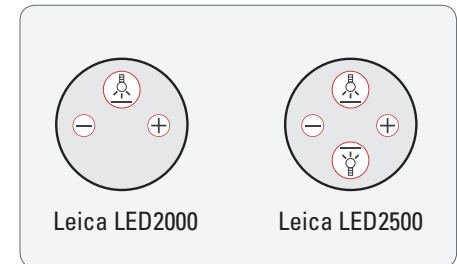

Illumination Types and Results (Continued)

All power LEDs are on



This setting achieves the greatest brightness, while the effects of highlights and shadows are reduced by the dominant ring illuminator. This setting is ideal for observing dark, flat, non-reflective specimens.

Ring illuminator on



This illumination type results in very bright, homogeneous lighting virtually without shadows. The ring illuminator is often used when observing specimens with strongly fissured or porous surfaces.

Illumination Types and Results (Continued)

Only the upper two power LEDs of the arc illuminator are on



The resulting side light results in images with pronounced light/shadow effects not unlike those of a swan-neck light guide. Scratches and other recesses become easier to identify.

Only the lowest power LED of the arc illuminator is on



This illumination results in a pseudo-darkfield effect. The image becomes darker and exhibits extreme contrasts. The 3D effect of flat specimens is enhanced. Dirt and dust particles become very easy to identify.

Illumination Types and Results (Continued)

The diffuse transmitted light illumination is switched on



The transmitted light of the Leica LED2500 can be used to examine transparent samples. The uniform transmitted light is ideally suited for colored, high-contrast samples. With a large diameter of 60 mm, it is also suitable for over-view observations at low magnifications. The results can be optimized using different brightness levels.

Only the central LED of the transmitted light illumination is switched on

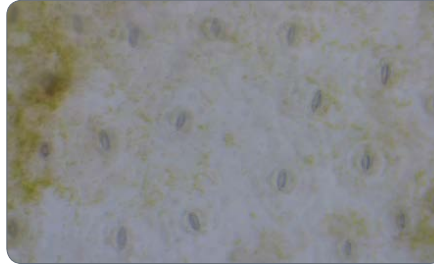

diffuse transmitted light

Semi-transparent samples are optimally contrasted with the optimized transmitted light. The centrally positioned LED, which emits directed light onto the sample, enables clear visualization even of structures that have very low contrast. Can be used ideally for high magnification levels.

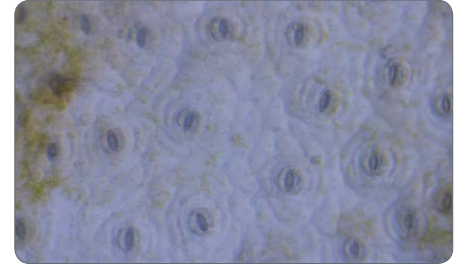

only directed transmitted light

The images clarify how the directed transmitted light improves the contrast of the sample. As a result, the structures and differences within the sample are brought out significantly better.

Service

Care, Maintenance, Contact Persons

General

We hope you enjoy using your Leica LED2000 / LED2500. Leica stands are renowned for their robustness and long service life. Observing the following care and cleaning tips will ensure that even after years and decades, your Leica stand will continue to work as well as it did on the very first day.

Warranty benefits

The guarantee covers all faults in materials and manufacture. It does not, however, cover damage resulting from careless or improper handling.

Contact address

If your instrument no longer works perfectly, contact your Leica Microsystems representative. You can find information on worldwide Leica representatives on the Leica Microsystems website: www.leica-microsystems.com.

Care, Maintenance, Contact Persons (Continued)

Care

- Keeping all optical components clean is important for maintaining good optical performance.
- If any optical surface becomes badly coated with dust or dirt, flush the surface using a syringe or by brushing it off with a camel hair brush before attempting to wipe it clean.
- Optical surfaces should be cleaned using a lint-free cloth, lens cloth or cotton swab soaked in ethanol or a commercially available glass cleaner. Do not use alcohol.
- Avoid excessive use of solvents. The lint-free cloth, lens cloth or cotton swab should be soaked with solvent, but not so wet that solvent runs over the lens.
- Protect your stand from moisture, fumes and acids and from alkaline, caustic and corrosive materials and keep chemicals away from the instruments.
- Plugs, optical systems and mechanical parts must not be disassembled or replaced, unless doing so is specifically permitted and described in this manual.
- Protect your stand from oil and grease.
- Do not grease guide surfaces or mechanical parts.

Protection from dirt

Dust and dirt will affect the quality of your results.

- Put an optionally available dust cover over the stand when it will not be used for a long time.
- Keep accessories in a dust-free place when not in use.

Care, Maintenance, Contact Persons (Continued)

General information

The Leica LED2000 / LED2500 can be cleaned easily with a soap solution and water. Do not use caustic or abrasive cleansers.

Special notes on the Leica LED2000

The base of the Leica LED2000 features openings through which spilled liquids can drain. Simply remove the stage plate and clean the base with a soap solution. Wipe it dry with a clean cloth.

Special notes on the Leica LED2500

The transmitted illumination unit of the Leica LED2500 is sealed and thus waterproof. Remove the glass plate and clean the base with soap solution. Wipe it dry with a clean cloth.

The buttons

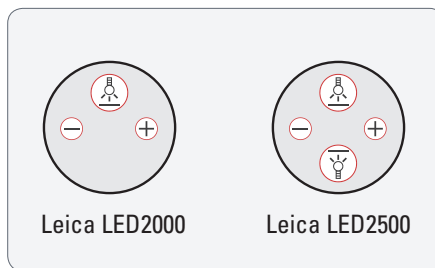

The buttons of the illumination are waterproof. Clean the membrane switches with soap solution. Wipe then dry with a clean cloth. Do not use abrasive cleansers!

Servicing

- Repairs may only be carried out by Leica Microsystems-trained service technicians. Only original Leica Microsystems spare parts may be used.

Danger of electric shock



Risk of electric shock. Removing the cover of the Leica LED2000 / LED2500 exposes electrically live parts, which, if touched, can cause potentially fatal injuries. Have technical service carried out by a Leica Microsystems authorized dealer.



Specifications

Technical Data

Leica LED2000 / LED2500	
Light sources	Power LEDs, 1.2 Watt (4 LEDs for the ring illuminator, 3 for the arc illuminator)
Illumination	Incident light (4-point ring illumination) Oblique light (3-point arc illumination) 4 switchable scenarios
	Transmitted light (5 LEDs with central LED for high contrast) 3 switchable scenarios
Average LED life	approx. 25 000 hours
Color temperature	6 100 K (Incident light) 5 800 K (Transmitted light LED2500 only)
Cooling	Thermo-management for the LEDs, silent and vibration-free
Illumination control	Incident light and transmitted light can be controlled separately
Intensity setting	10 steps

Integrated power supply	100 V – 240 V ~ 50 / 60 Hz Automatic adjustment to local voltage
Power consumption	max. 30 W
USB port *	+5 V / 500 mA
Standards compliance	CE, cUL, UL
ESD design	antistatic

* No data transfer or control is possible
NOT suitable for connecting to a computer

Dimensional Drawings Leica LED2000 / LED2500

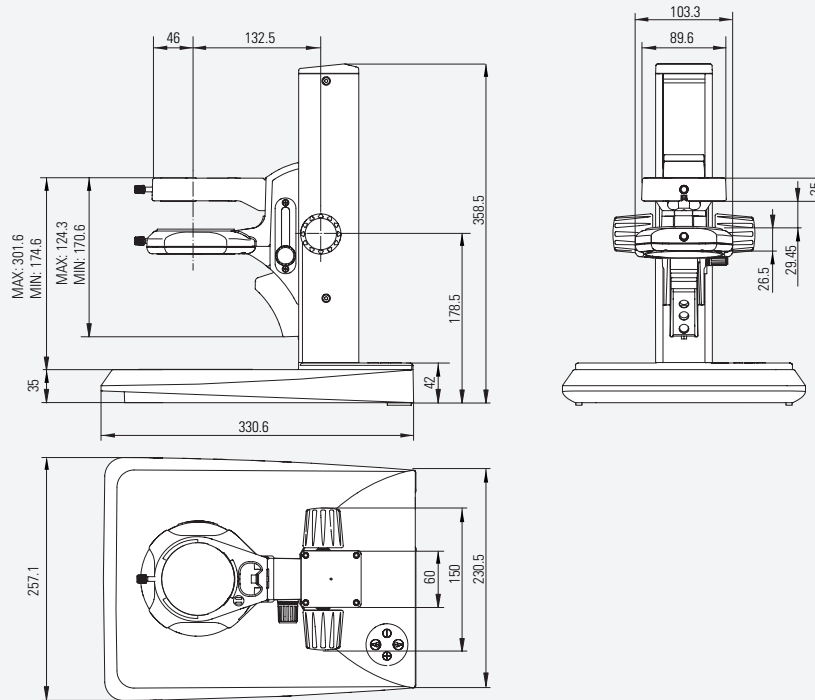

Dimensions in mm

The statement by Ernst Leitz in 1907, *“With the User, For the User,”* describes the fruitful collaboration with end users and driving force of innovation at Leica Microsystems. We have developed five brand values to live up to this tradition: Pioneering, High-end Quality, Team Spirit, Dedication to Science, and Continuous Improvement. For us, living up to these values means: **Living up to Life.**

INDUSTRY DIVISION

The Leica Microsystems Industry Division’s focus is to support customers’ pursuit of the highest quality end result. Leica Microsystems provide the best and most innovative imaging systems to see, measure, and analyze the microstructures in routine and research industrial applications, materials science, quality control, forensic science investigation, and educational applications.

Leica Microsystems – an international company with an experienced worldwide customer service network.

Active worldwide	Tel.	Fax
Australia · North Ryde	+61 2 8870 3500	2 9878 1055
Austria · Vienna	+43 1 486 80 50 0	1 486 80 50 30
Belgium · Diegem	+32 2 790 98 50	2 790 98 68
Canada · Concord/Ontario	+1 800 248 0123	847 405 0164
Denmark · Ballerup	+45 4454 0101	4454 0111
France · Nanterre Cedex	+33 811 000 664	1 56 05 23 23
Germany · Wetzlar	+49 64 41 29 40 00	64 41 29 41 55
Italy · Milan	+39 02 574 861	02 574 03392
Japan · Tokyo	+81 3 5421 2800	3 5421 2896
Korea · Seoul	+82 2 514 65 43	2 514 65 48
Netherlands · Rijswijk	+31 70 4132 100	70 4132 109
People’s Rep. of China	· Hong Kong +852 2564 6699	2564 4163
	· Shanghai +86 21 6039 6000	21 6387 6698
Portugal · Lisbon	+351 21 388 9112	21 385 4668
Singapore	+65 6779 7823	6773 0628
Spain · Barcelona	+34 93 494 95 30	93 494 95 32
Sweden · Kista	+46 8 625 45 45	8 625 45 10
Switzerland · Heerbrugg	+41 71 726 34 34	71 726 34 44
United Kingdom · Milton Keynes	+44 800 298 2344	1908 246312
USA · Buffalo Grove/Illinois	+1 800 248 0123	847 405 0164

10IDS12060EN · Copyright © by Leica Microsystems (Schweiz) AG, CH-9435 Heerbrugg, 2014. Subject to change. LEICA and the Leica Logo are registered trademarks of Leica Microsystems IR GmbH.