

Living up to Life

Leica
MICROSYSTEMS

Leica DM4000 M LED Leica DM6000 M

Leica DigitalMicroscopes for Materials Sciences



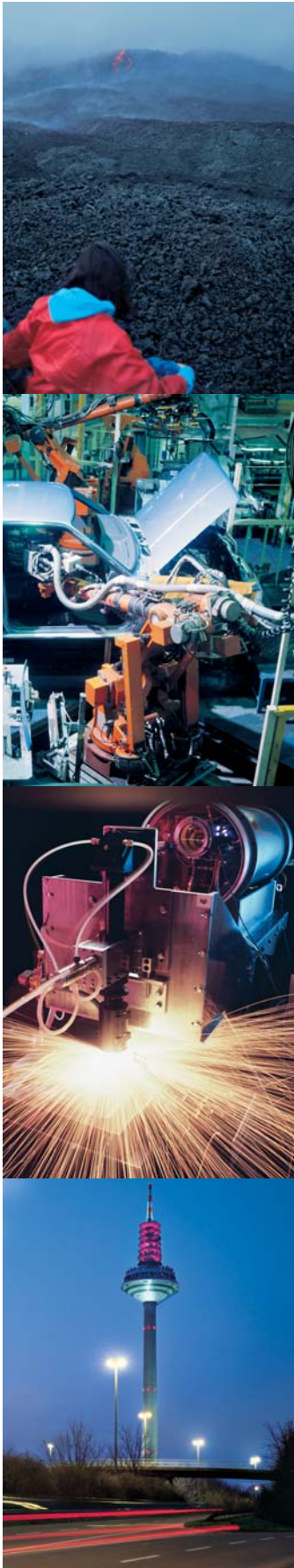

Brilliant discoveries ... this is why you entered science.

It's what you work for every day.

The new generation of Leica DigitalMicroscopes will help you make your next brilliant discovery.

Brilliant, Easy Imaging at the Speed of Light

Innovative design and technological excellence

At first glance: a clean, attractive design. Looking through the microscope for the first time: fascinating insights. The Leica DigitalMicroscope family: unrivaled image brilliance, focus depth, and image contrast in this class of microscope.

New standards for ease of use

Work quickly and more efficiently with Leica's new generation of DigitalMicroscopes. The perfect match of high-quality optics, logical functionality, and innovative software means the user can operate the microscope intuitively and easily automate complex laboratory routines to save valuable time.

User-friendly through ergonomics

Ergonomics is a word often heard to describe ease of use. With Leica DigitalMicroscopes, ergonomic design means a user-friendly microscope system that you can actually feel. Working closely with the Fraunhofer Institute*, Leica designed these microscopes to not only exceed the latest technical standards, but also to meet the highest standards of ergonomic design.

* Registered prototype DE 402 04 845; patented DE 101 26 291

** The Fraunhofer Institute IAO (Stuttgart, Germany) investigates the ergonomic qualities of various products. Working together with their partners in industry, the Fraunhofer Institute develops industrial designs that meet the highest ergonomic standards.



Leica Design by Christophe Apothéloz

Ease of Use ...

Benefits Your Work

Leica's Intelligent Automation:

- Automated contrast manager and illumination manager
- Constant Color Intensity Control (CCIC)
- Automated incident light interference contrast (ICR)
- All illumination settings are individually adjustable and can be manually controlled.
- Variable stage speed and step size of the z focus
- Automated condensers (1.25x–100x)

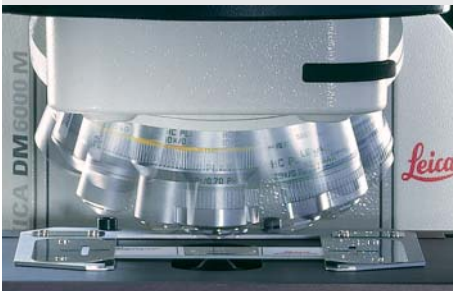

Each time an objective is changed, the illumination manager correctly determines the best parameters for the aperture and field diaphragm.

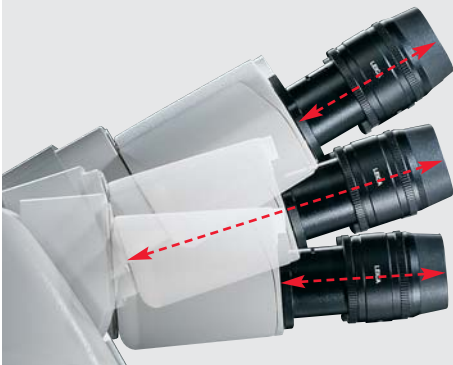

Leica's AET22 adaptable tube, with variable eyepiece extension, precisely adjusts to an individual's seated height.

The best view – automatically

Leica DigitalMicroscopes can automatically detect the contrast method and objective that are currently in use. Manual diaphragm settings are a thing of the past. The microscope's light intensity automatically adapts to the objective in use, which ensures that the brightness of the sample being viewed always remains the same. The automated condenser heads automatically swing in and out depending on the objective's magnification.

Leica DigitalMicroscopes adapt to the individual user

Leica DigitalMicroscopes can be configured with an adaptable tube that perfectly adjusts to individual's seated height. A user can reach the focus knobs with his or her hands resting comfortably on the table. The adaptable stage makes simultaneous focus and stage movement control easy. These features promote a relaxed body position at the microscope – even after long sessions of sitting at the microscope.

Stages and specimen holders – durable and convenient

Leica's microscope stages are designed to withstand the most demanding applications. They feature a scratch-resistant ceramic coating and telescopic stage drives with individually adjustable torque. The stages can be rotated up to 110°, are suitable for holding one or two samples, and are available in a left-handed version. For even more comfort: motorized stages are available for the Leica DM6000 M.

Five tube variations provide pin-sharp images

Choose from an extensive selection of tubes. Leica's documentation tubes (which can be motorized on request) have three switching positions. Some tubes are equipped with one or two optional camera outputs. And Leica's product range includes an ergonomic tube with a documentation port.

One-of-a-kind: Constant Color Intensity Control (CCIC)

The transmitted light axis of the Leica DM6000 M operates with an automatic Constant Color Intensity Control that maintains a constant color temperature. CCIC makes white balancing, when the light intensity changes, unnecessary. The Leica DM4000 M LED utilizes the innovative LED-illumination technology for all prevalent contrasting techniques such as BF, DF, ICR and Polarized light. The key benefits of LED-illumination are: long life time of the LED, no bulb exchange necessary, constant color temperature, low heat development.

Clarity wherever you look

While working at the microscope, the user can control the Leica DM6000 M using the clearly arranged Leica SmartTouch panel, which is integrated within the stand. All automated functions of the Leica DigitalMicroscope can also be controlled remotely, conveniently, and intuitively using the new, external Leica STP6000 SmartTouch Panel from any position on the workstation. The large, clearly arranged display of each panel shows all settings at a glance for unmatched convenience.

All microscope functions within easy reach

Programmable function buttons are available for the user to easily assign to any desired microscope function. Six of the conveniently arranged buttons are located on the stand behind the focus knobs to provide easy, fast access to the functions used most. Additional function buttons are available on the external Leica STP6000 SmartTouch Panel or on the Leica SmartMove remote control (not shown).

Panorama objective provides the best overview

Leica's powerful 1.25x scanning objective has been specifically designed for materials science applications. In combination with the reflected light axis, this objective provides excellent depth of field and the highest degree of illumination homogeneity for low magnification imaging.



One-of-a-kind – the Leica SmartTouch panel is integrated within the front side of the microscope stand for easy control of the microscope functions.

Convenience to the last detail:

- New: status display or intuitive control of the microscope using the integrated Leica SmartTouch panel
- New: optional, external Leica STP6000 SmartTouch Panel for remote control of the microscope
- Variety of adaptable tubes and ergonomic tubes with variable viewing angle for user comfort
- Low-position focus knobs for comfortable, convenient microscope operation



The new Leica STP6000 SmartTouch Panel provides intuitive remote control of the automated microscope functions.



Configure specific illumination and diaphragm settings with the buttons on the left front side.

Automation ... Saves Time and Streamlines

Incident light

Leica's incident light axis is automated. The motorized aperture and field diaphragms ensure 100% reproducibility. The reflector disk for four positions is also motorized and holds the optical components for all incident light contrast methods.

Work at the microscope was never this easy

Adjust the sample on the microscope stage, focus – and the work is done. For incident light brightfield methods, the Leica DigitalMicroscope automatically recognizes the objective in use, accurately opens and closes the aperture and field diaphragms, and adapts the light intensity.

Set at the touch of a button – incident light darkfield

Leica's motorized darkfield block on the reflector disk automatically moves into the beam path. The DigitalMicroscope automatically adjusts the settings to the changed contrast mode.

Fully automated option for incident light polarization

Leica offers a motorized version of the incident light polarization contrast, which includes the polarizer and analyzer within the ICR reflector, on the motorized reflector disk.

Always the correct prism for incident light interference contrast (ICR)

For the Leica DM4000 M LED, an ICR system is available in semi-automated and fully manual versions. To prevent operational errors, the correct prism is displayed – the user simply inserts the prism into the beam path. For the Leica DM6000 M, all ICR components are fully automated. Leica's ICR system requires only one prism for many objective sets.

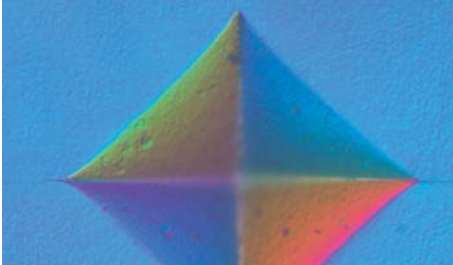

Microhardness impression



Aluminum, Barker etching, polarization



Workflow

Transmitted light

In addition to the motorized aperture and field diaphragms, Leica's transmitted light axis of the DM6000 M also features Constant Color Intensity Control (CCIC). CCIC ensures a constant color temperature over a wide brightness range, which makes additional adjustments to the microscope and camera unnecessary. The Leica DM4000 M LED features color constant LED-illumination to ensure reproducible image quality.

Automatically configured – for transmitted light brightfield and . . .

In both incident light and transmitted light modes, Leica DigitalMicroscopes automatically and correctly configure the aperture diaphragm, field diaphragm, and lamp voltage. Also, in transmitted light mode, the condenser head swings in and out according to the objective selected. The CCIC of the DM6000 M also filters out the red and orange hues from the light at low lamp voltages.

. . . for all other transmitted light contrast methods

All other transmitted contrast methods, including phase contrast, interference contrast, and polarization, are automated.

Switch contrast method more easily than ever before

Leica's technique of switching contrast methods is unique. One press of the function buttons is all it takes to switch the microscope between brightfield, dark-field, phase contrast, polarization, or interference contrast. All of the required settings to adapt to the switch between incident light and transmitted light methods are saved. And at the touch of a button, the last setting reached is restored.

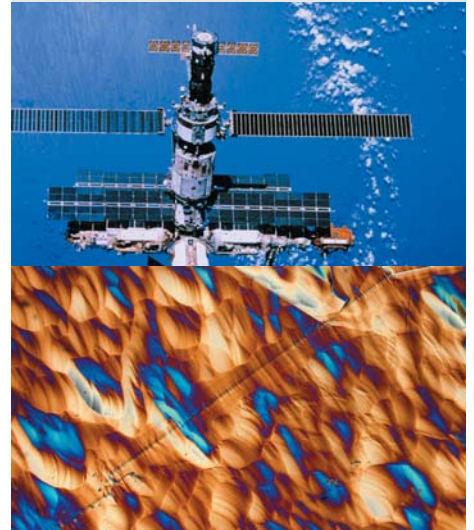

Solar cell, ICR (incident light interference contrast)

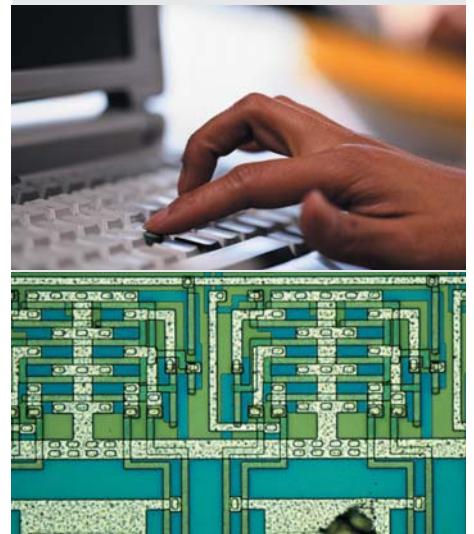

IC chip, incident light brightfield

System Solutions for a Variety of Applications

The choice is yours – at any time

Leica offers a new software platform that seamlessly integrates the entire imaging system and allows the user to upgrade the microscope system at any time: Leica Application Suite (LAS). Future Leica software and hardware components will also be controlled using the intuitive LAS user interface.

Microscope, camera, and software – the perfect team

The Leica DigitalMicroscope, camera, and documentation controls are seamlessly and conveniently integrated via Leica Application Suite (LAS) software. In addition, all microscope and camera parameters are quickly saved and archived along with the images, and then reproduced as necessary.

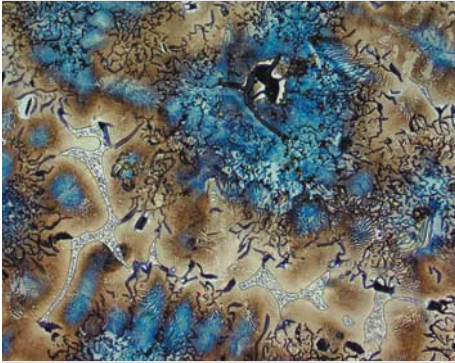

Cast iron, GG-18, incident light, brightfield

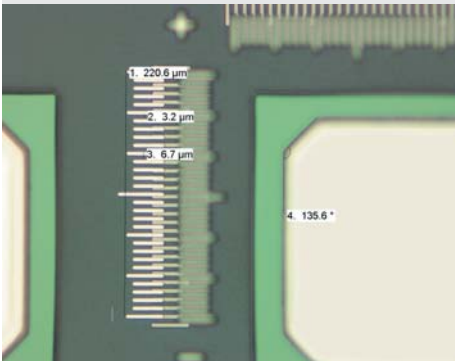

IC chip contact point measurement



Individual microscope configuration and control

The user interface is convenient to use. On the Leica DM6000 M, the user can program and operate the function buttons, contrast methods, and all other microscope settings quickly and easily to suit the specific work at hand – via a computer, the integrated Leica SmartTouch panel, the Leica SmartMove remote control, or the external Leica STP6000 SmartTouch Panel.

Digital cameras for every requirement

Leica's new digital cameras offer easy image documentation for every application. The standard FireWire interface provides a fast means of transferring images to PCs and Mac computers. The cameras can produce both color and black and white images, and feature easy-to-use white balance and shading correction.

Perfect image archiving and analysis

With the Leica LAS Archive module, the user can document, edit, and review microscopic images. In addition, all microscope and camera parameters can be quickly and easily saved and archived along with the images.

For more highly application-specific image analysis, The Leica MW Materials Workstation offers software packages for grain size analysis, phase percentage measurement, layer thickness measurement, and contamination measurement of filters. Using Leica Steel Expert software, for example, non-metallic inclusions in steel can be measured, fully automatically. The steel inclusion evaluation can then be displayed in all common industry standards.

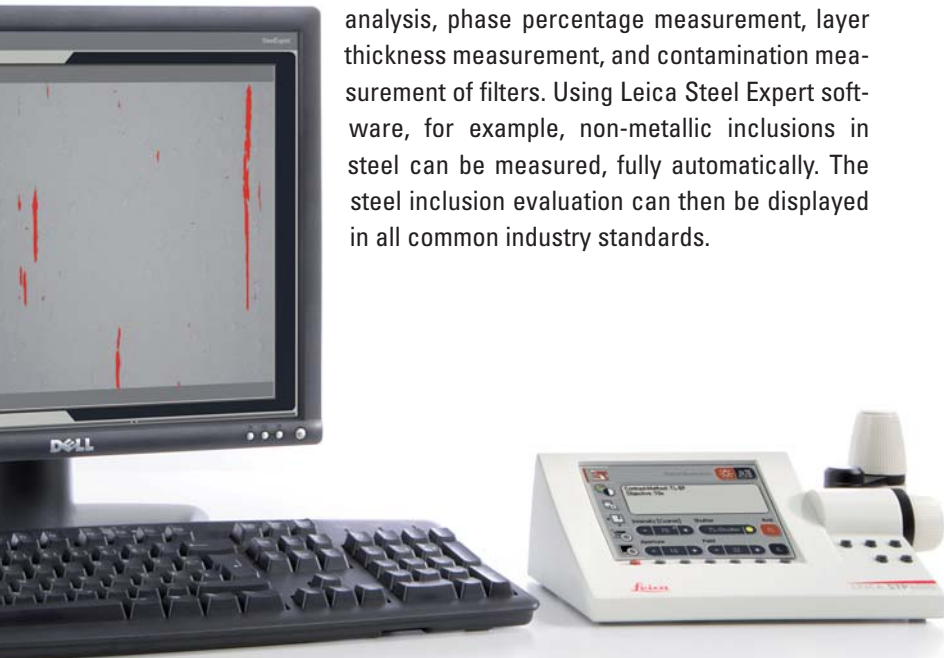

Complete system integration:

- Configuration and control of the microscope and camera via LAS software
- Modular LAS software can be added to at any time
- Leica offers the best digital camera for every application
- All microscope and camera settings can be saved and reproduced at any time
- Image analysis and archiving modules for various materials analyses



The Leica DM6000 M's motorized stages can be controlled using LAS software.

The New Generation of LED-DigitalMicroscopes









Leica DM4000 M LED with incident light and transmitted light axis

Leica DM4000 M LED –

The ideal microscope for high-end routine applications

The new generation Leica DM4000 M LED offers a state-of-the-art LED-illumination for all prevalent contrasting methods and many other features that make work at the microscope even faster and more reliable.

- Automated microscope for reproducible results and time-saving work
- LED-illumination with constant colour temperature for all contrasting methods.
- New, clearly arranged display that shows all settings at a glance
- The modular microscope design ensures a system that is perfectly tailored to specific needs
- Optional, fully automated incident light axis for brightfield, darkfield, polarization, interference contrast, and fluorescence (additional illumination components required)
- Incident light with 4-position reflector disk (two fixed positions, two variable positions) for reflectors or fluorescence filter cubes
- Fully automated transmitted light axis* for all common methods (brightfield, darkfield, phase contrast, polarization, interference contrast) with colour-neutral LED-illumination
- Standard microscope models are equipped with fully automated illumination manager and contrast manager, as well as fully motorized aperture and field diaphragms
- Manual 6-position objective nosepiece
- Manual z drive and manual stage
- The microscope meets high standards at an attractive price

	IL_BF	↓	↑
	10x Obj. 1.5x MagCh.	Σ 150x	
	INT 100%	AP 8	FD 3○
	 80%	 → 20%	

Everything you see in the display of the Leica DM4000 M is saved automatically and can be reproduced at any time.

* A transmitted light axis cannot be retrofit later. All Leica DigitalMicroscopes, on request, are available with an encoded magnification changer or MBDT motorized documentation tube, which complements Leica's extensive line of products.

Leica DM6000 M –

The research microscope that leaves nothing to be desired

The intelligent automation of the Leica DM6000 M extends throughout the entire microscope systems, even to the smallest component.

- Perfectly tailored system for research tasks – with high-resolution digital cameras and software modules for image analysis and archiving
- Fully automated incident light axis for brightfield, darkfield, polarization, interference contrast, and fluorescence
- Incident light with 4-position reflector disk (two fixed positions, two variable positions) for reflectors or fluorescence filter cubes
- Optional, fully automated transmitted light axis* for all common methods (brightfield, darkfield, phase contrast, polarization) and with CCIC (Constant Color Intensity Control)
- Automated illumination manager and contrast manager, and fully motorized aperture and field diaphragms
- Motorized z focus drive and motorized stages, reproducible x, y, and z positions
- Motorized, encoded 6-position objective nosepiece
- One-of-a-kind memory function for simultaneous changeover of the objective and contrast method
- Integrated Leica SmartTouch panel for control and monitoring of all automated components
- Optional, external Leica STP6000 SmartTouch Panel for intuitive and vibration-free remote control



The new, external Leica STP6000 SmartTouch Panel provides convenient, remote control of all of the microscope's automated functions. It provides the same graphical user interface as LAS software.



Leica DM6000 M with MBDT motorized documentation tube and motorized stage

Specifications

		Leica DM4000 M LED	Leica DM6000 M
Stand	Power supply	– Integrated within stand	– In CTR6000 electronics box
	Display	– Information display (3.7 x 7.7 cm)	– Leica SmartTouch (7.3 x 7.3 cm) with information and control panels
	Interface	– 1 x USB 2.0	– 2 x USB 2.0
Operation	Focus	– Manual – 2-gear drive – Optionally motorized	– Motorized – 5 electronic transmissions – with parfocality function – toggling between coarse and fine mode – place in memory for 2 Z positions
	Objective nosepiece	– Absolute encoded – 6x M32 thread	– Absolute encoded and motorized – 6x M32 thread – Including dry and immersion mode
	Stages	– Manual – ceramic-coated – Y-drive with cable control – telescopic stage drive with adjustable torque – Manual – 4" x 4" – Manual – 8" x 4" – Manual – with inverted stage drive (for tall samples) – 6" x 6" for large samples	– Motorized – with stepper motor – toggling between quick and precision mode – incl. storage space for up to 6 stage positions – Manual – ceramic-coated – Y-drive with cable control – telescopic stage drive with adjustable torque – Manual – 4" x 4" – Manual – 8" x 4" – Manual – with inverted stage drive (for tall samples) – 6" x 6" for large samples
Transmitted light Axis	Illumination	– LED 4500K	– 12 V 100 W halogen lamp
	Automation	– Automatic illumination manager (Brightness adjustment) – Automatic contrast manager (adjustment of field and aperture diaphragm) – Constant Color Intensity Control with LED-technology	– Automatic illumination manager (Brightness adjustment) – Automatic contrast manager (adjustment of field and aperture diaphragm) – Constant Color Intensity Control
	Contrast method	– BF, POL, PH, DIC	– BF, POL, PH, DIC
Incident light axis	Mot. filter disk	– 4x – 2 fixed positions – 2 variable positions	– 4x – 2 fixed positions – 2 variable positions
	Illumination	– White light LED – 100 W mercury lamp – 50 W mercury lamp	– 100 W halogen lamp – 100 W mercury lamp – 50 W mercury lamp
	Automation	– Automatic illumination manager (Light intensity adjustment) – Automatic contrast manager (adjustment of field and aperture diaphragm) – Circular and rectangular field diaphragms for eyepiece or camera observation	– Automatic illumination manager (Light intensity adjustment) – Automatic contrast manager (adjustment of field and aperture diaphragm) – Circular and rectangular field diaphragms for eyepiece or camera observation
	Contrast method	– BF – DF – POL – DIC (partially automated) – Fluorescence	– BF – DF – POL – DIC (automated) – Fluorescence
Condenser	Automation	– Mot. condenser head – Mot. 7x condenser disk (optional) – Mot. polarizer (optional)	– Mot. condenser head – Mot. 7x condenser disk (optional) – Mot. polarizer (optional)

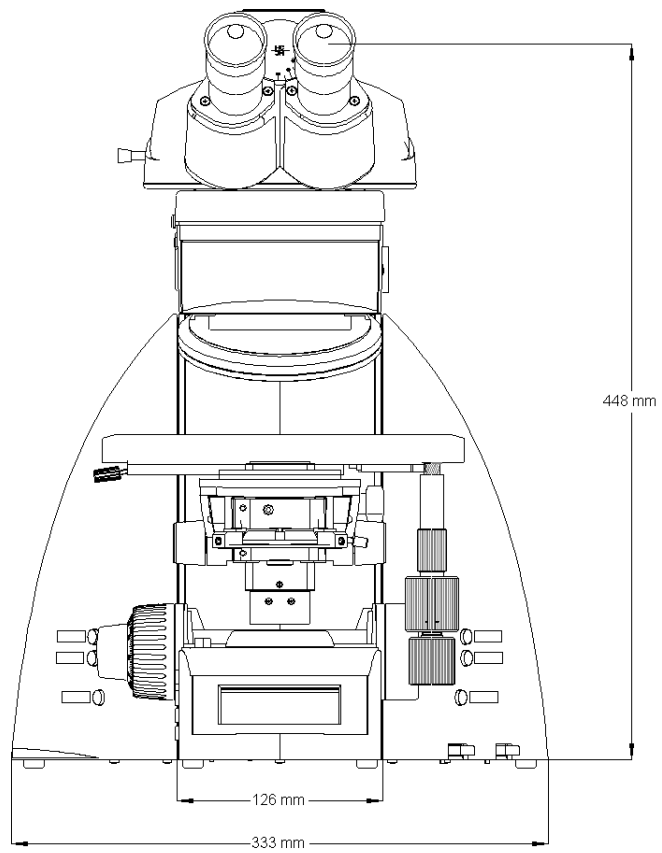
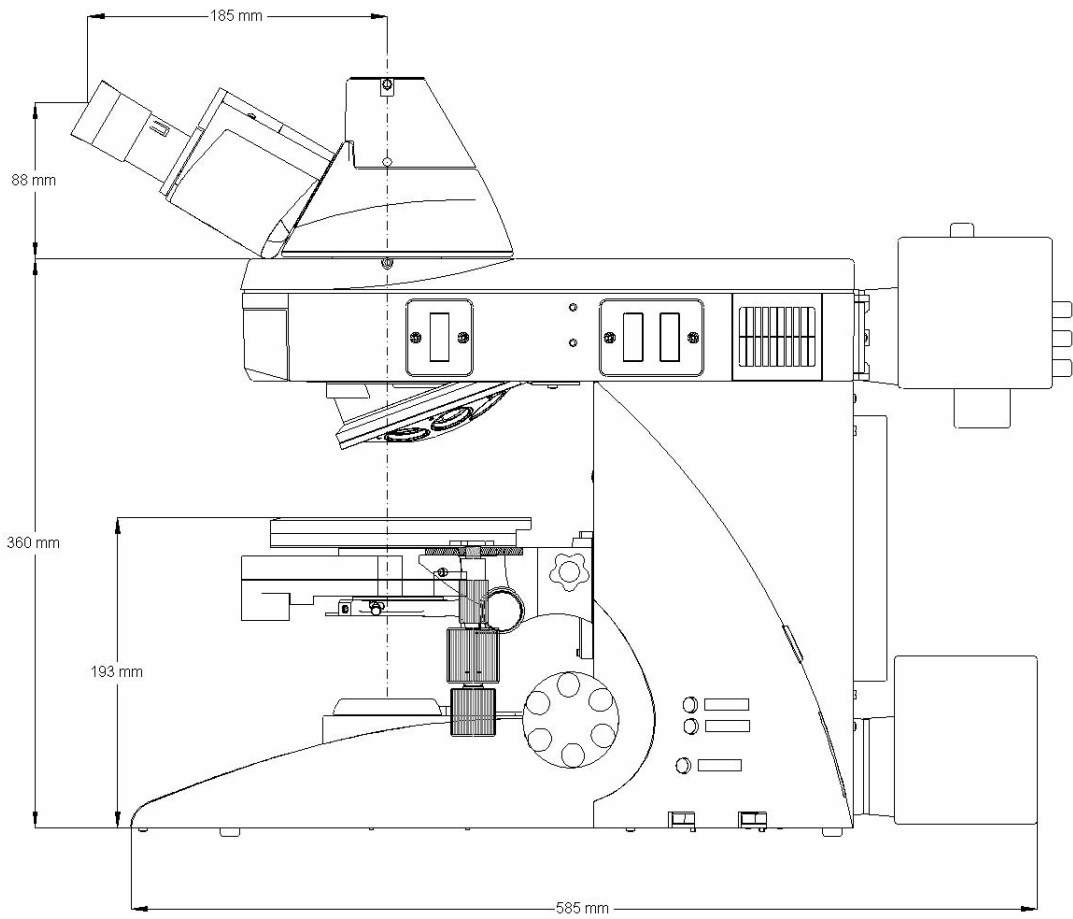

System overview

Leica DM4000 M LED/DM6000 M/DM4500 P LED

Tube program L

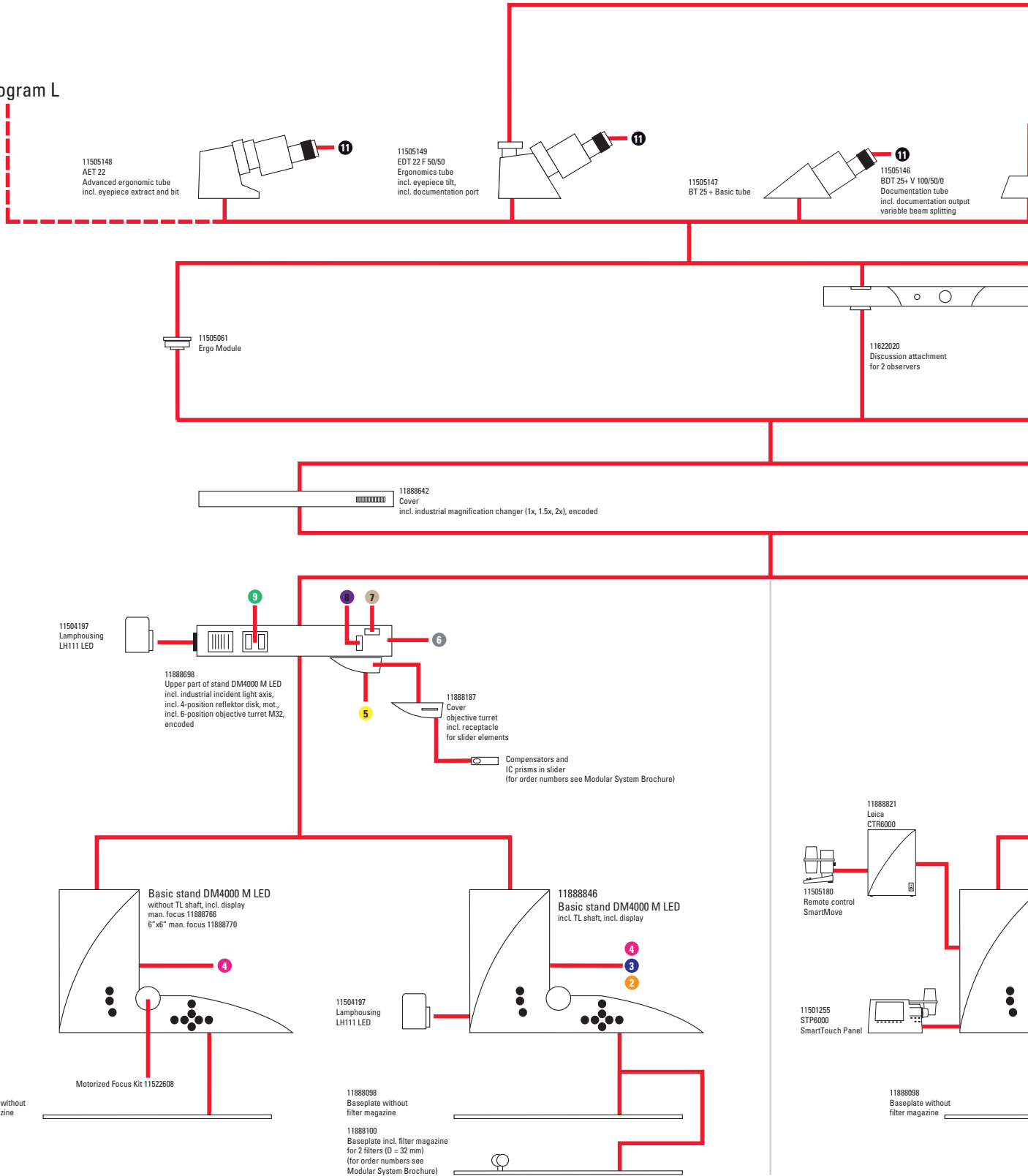

Leica DM4000 M LED

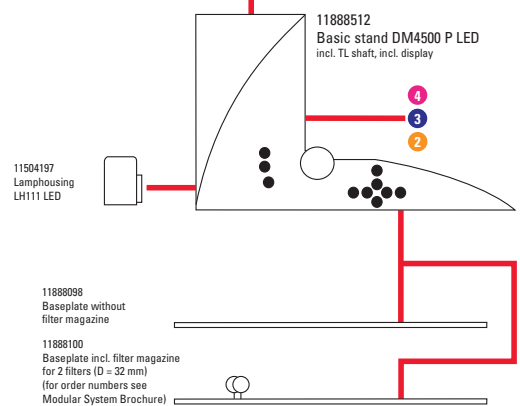
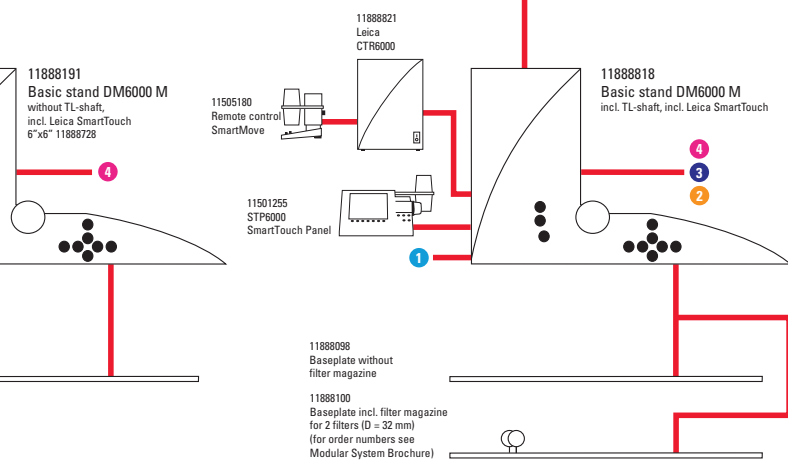
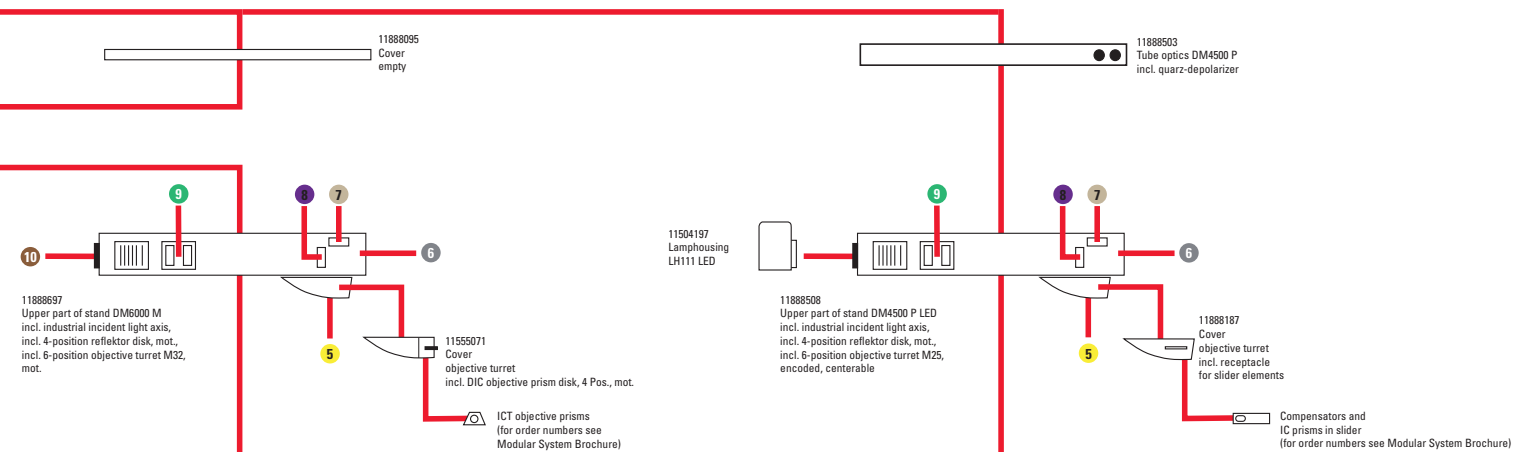
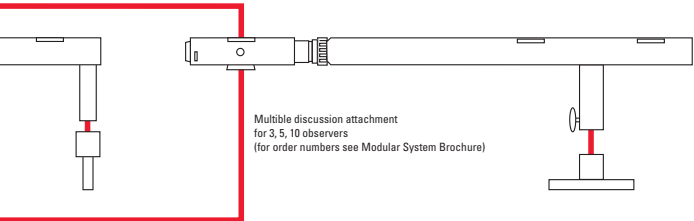
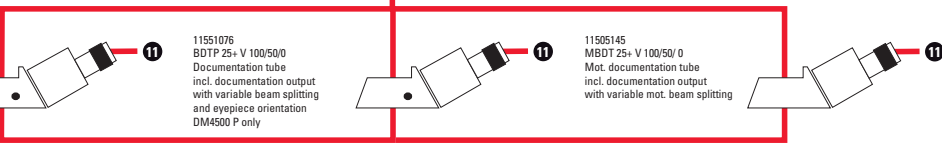
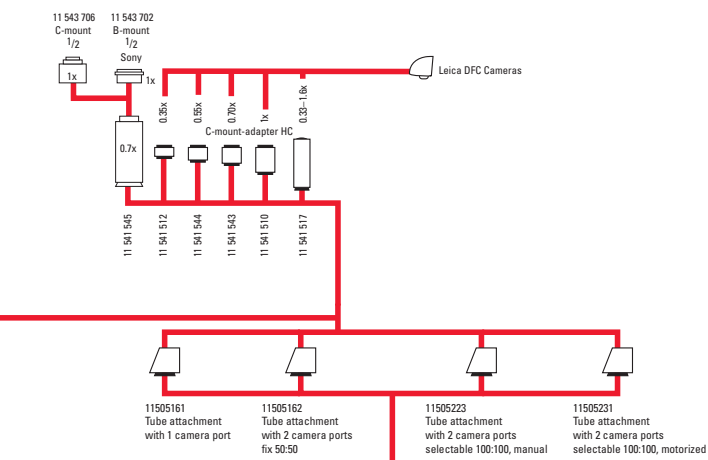

Leica DM6000 M

Leica DM4500 P LED

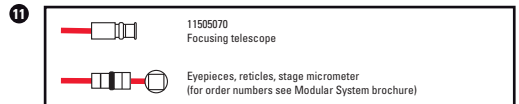
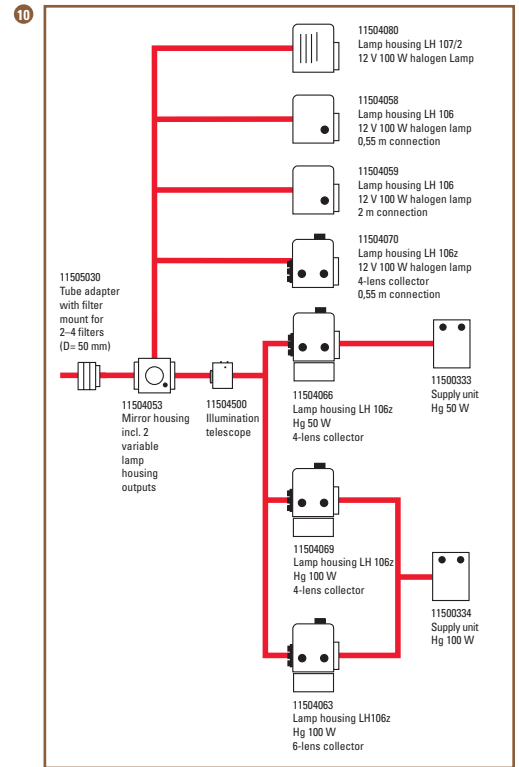
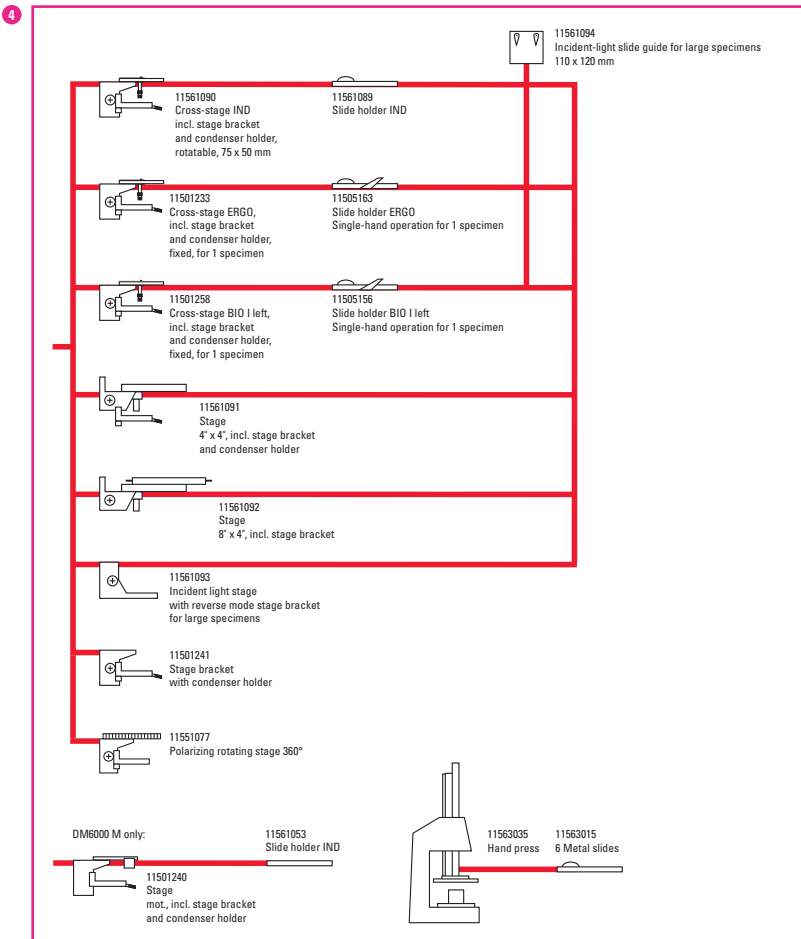
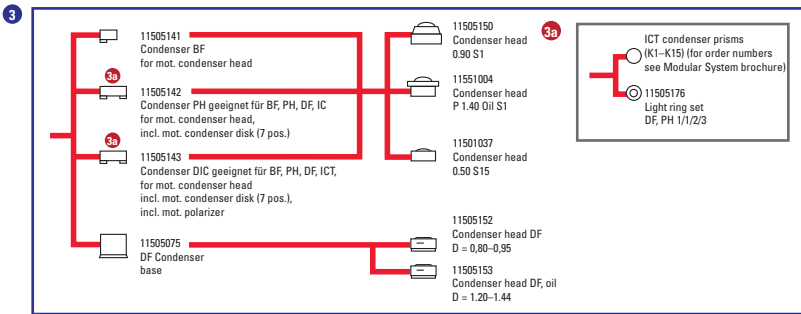
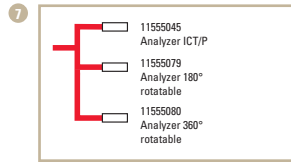
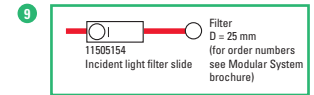
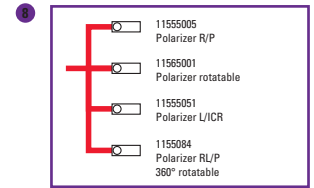
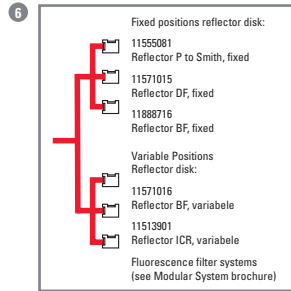
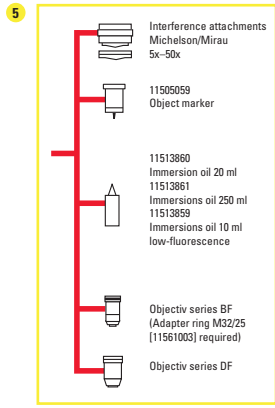
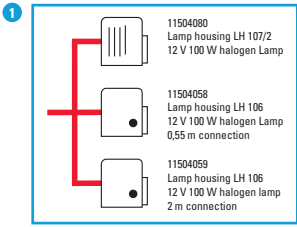



The statement by Ernst Leitz in 1907, *“With the User, For the User,”* describes the fruitful collaboration with end users and driving force of innovation at Leica Microsystems. We have developed five brand values to live up to this tradition: Pioneering, High-end Quality, Team Spirit, Dedication to Science, and Continuous Improvement. For us, living up to these values means: **Living up to Life.**

Leica Microsystems operates globally in three divisions, where we rank with the market leaders.

LIFE SCIENCE DIVISION

The Leica Microsystems Life Science Division supports the imaging needs of the scientific community with advanced innovation and technical expertise for the visualization, measurement, and analysis of microstructures. Our strong focus on understanding scientific applications puts Leica Microsystems’ customers at the leading edge of science.

INDUSTRY DIVISION

The Leica Microsystems Industry Division’s focus is to support customers’ pursuit of the highest quality end result. Leica Microsystems provide the best and most innovative imaging systems to see, measure, and analyze the microstructures in routine and research industrial applications, materials science, quality control, forensic science investigation, and educational applications.

MEDICAL DIVISION

The Leica Microsystems Medical Division’s focus is to partner with and support surgeons and their care of patients with the highest-quality, most innovative surgical microscope technology today and into the future.

Leica Microsystems – an international company with a strong network of worldwide customer services:

Active worldwide		Tel.	Fax
Australia · North Ryde	+61	2 8870 3500	2 9878 1055
Austria · Vienna	+43	1 486 80 50 0	1 486 80 50 30
Belgium · Diegem	+32	2 790 98 50	2 790 98 68
Canada · Concord/Ontario	+1	800 248 0123	847 405 0164
Denmark · Ballerup	+45	4454 0101	4454 0111
France · Nanterre Cedex	+33	811 000 664	1 56 05 23 23
Germany · Wetzlar	+49	64 41 29 40 00	64 41 29 41 55
Italy · Milan	+39	02 574 861	02 574 03392
Japan · Tokyo	+81	3 5421 2800	3 5421 2896
Korea · Seoul	+82	2 514 65 43	2 514 65 48
Netherlands · Rijswijk	+31	70 4132 100	70 4132 109
People’s Rep. of China · Hong Kong	+852	2564 6699	2564 4163
· Shanghai	+86	21 6387 6606	21 6387 6698
Portugal · Lisbon	+351	21 388 9112	21 385 4668
Singapore	+65	6779 7823	6773 0628
Spain · Barcelona	+34	93 494 95 30	93 494 95 32
Sweden · Kista	+46	8 625 45 45	8 625 45 10
Switzerland · Heerbrugg	+41	71 726 34 34	71 726 34 44
United Kingdom · Milton Keynes	+44	800 298 2344	1908 246312
USA · Buffalo Grove/Illinois	+1	800 248 0123	847 405 0164