



# Leica A60 S Manual

# Table of Contents

## The Leica A60 S

Congratulations!	13
An Overview of the Leica A60 S	14

## Assembling the Leica A60 S

Column and Baseplate	16
Safety Ring and Horizontal Arm	17
Grounding	18
Assembling the Optics Carrier	19
Fastening the Leica A60	20
Assembling the Illuminator	21

## Using the Leica A60 S

Adjusting the Working Height	23
The Correct Interpupillary Distance	25
Focusing	26
Magnification Display	27
Dioptic Correction and Parfocality	28
Adjusting the Resistance of the Focus Drive	29
Leica A60 LED Ring Illuminator	30
Replacing the Protective Glass	31

## Dimensions

Dimensions	33
------------	----

## Optical Data

Optical Data	36
--------------	----



# Safety Instructions

## Symbols used in this operating manual

### Warning! Safety hazard!



This symbol indicates especially important information that is mandatory to read and observe.

Failure to comply can cause the following:

- Hazards to personnel
- Instrument malfunctions and damage

### Warning of hazardous electrical voltage



This symbol indicates especially important information that is mandatory to read and observe.

Failure to comply can cause the following:

- Hazards to personnel
- Instrument malfunctions and damage

### Danger due to hot surface



This symbol warns against touching accessible hot surfaces, e.g. those of light bulbs.

### Important information



This symbol indicates additional information or explanations that are intended to provide clarity.

# Important Notes

## Description

The Leica A60 S stereomicroscope meets today's state of the art of technology. Nevertheless, hazards may still arise during operation. The potential risks are described below.



Before installing, operating or using the instrument, it is mandatory to read this user manual. In particular, please observe all safety instructions.

## User Manual

This user manual includes important instructions related to operating safety, maintenance and accessories.



Your Leica A60 S stereomicroscope includes an interactive CD-ROM with all relevant user manuals. Keep it in a safe place, and readily accessible to the user. You can also download user manuals and updates from our website at [www.leica-microsystems.com](http://www.leica-microsystems.com)

## Legal requirements

Adhere to general and local regulations relating to accident prevention and environmental protection.

## EC Declaration of Conformity

Electrically operated accessories are constructed based on the state of the art of technology and are provided with an EC Declaration of Conformity.

# Instructions on use

## Intended use

The Leica A60 S stereomicroscope is an optical instrument for improving the visibility of objects through magnification and illumination.

The stereomicroscope may be used only in closed rooms and must be placed on a solid substrate.

The Leica A60 S stereomicroscope can be used in clean rooms.



Always position the stereomicroscope so that you can disconnect the illumination from the power supply at any time. The power cable must remain accessible at all times, because the power cable is intended as a power disconnect device.

## Place of use

Use the stereomicroscope in closed, dust-free rooms at +10 °C to +40 °C. Protect it from oil, chemicals and extreme humidity. Install electrical devices at least 10 cm from the wall and away from flammable substances.



In warm and warm-damp climatic zones, the individual components require special care in order to prevent the build-up of fungus.

## Non-intended use



Using the stereomicroscope in any way other than that described in the user manual may result in personal injury or damage to property. Doing so can impair the functions of the protective measures provided.



Never install any other plug (NEMA 5-15P) or unscrew any mechanical components unless expressly instructed to do so in the instructions.



The instruments and accessories described in this user manual have been tested for safety and potential hazards.

## Instructions on use (continued)



The responsible Leica affiliate must be consulted whenever the instrument is altered, modified or used in conjunction with non-Leica components that are outside of the scope of this manual!



Unauthorized alterations to the instrument or noncompliant use shall void all rights to any warranty claims.

### Transport

If at all possible, use the original packaging for shipping or transporting individual modules.

In order to prevent damage from vibrations, the customer should disassemble all moving parts according to the user manual and pack them separately.

### Disposal

Disposal must comply with locally applicable laws and regulations.

### Integration in third-party products

When installing Leica products into third-party products, the manufacturer of the complete system or its dealer is responsible for following all applicable safety instructions, laws and guidelines.

# Health risks and dangers of use

## Health risks



Workplaces with stereomicroscopes facilitate and improve the viewing task, but they also impose high demands on the eyes and holding muscles of the user. Depending on the duration of uninterrupted work at such a workplace, impaired vision and problems with the musculoskeletal system may occur. For this reason, appropriate measures for reduction of the workload must be taken:

- Optimum workplace layout
- Frequent changes of activity
- Thorough training of the personnel, giving consideration to ergonomic and organizational aspects

The ergonomic optical design and construction of the Leica stereomicroscopes are intended to reduce the exertion of the user to a minimum.

## Danger of infection



Direct contact with eyepieces is a potential transmission method for bacterial and viral infections of the eye.



The risk can be kept to a minimum by using personal eyepieces for each individual or detachable eyecups.

## Dangers during use

- The stereomicroscope must be connected to a grounded outlet.
- The stereomicroscope may be used when it is in proper working condition only.



# Information for the person responsible for the instrument

## Information for the person responsible for the instrument

- Ensure that the stereomicroscope is used only by persons qualified to do so.
- Ensure that this manual is always available at the place where the stereomicroscope is in use.
- Carry out regular inspections to make certain that the authorized users are adhering to safety requirements.
- When instructing new users, do so thoroughly and explain the meanings of the warning signs and messages.
- Assign individual responsibilities for starting, operating and servicing the instrument and monitor the observance of these responsibilities.
- Only use the stereomicroscope in proper condition.
- Inform your Leica representative or Leica Microsystems (Schweiz) AG, Industry Division, 9435 Heerbrugg, Switzerland, immediately of any product defect that could potentially cause injury or harm.
- If you use accessories from other manufacturers with the stereomicroscope, make sure that these manufacturers confirm that the combination is safe to use. Follow the instructions in the user manual for those accessories.
- Modifications to or service on the stereomicroscope may be carried out only by technicians who are explicitly authorized by Leica to do so.
- Only original Leica replacement parts may be used in servicing the product.
- After service work or technical modifications, the device must be readjusted in accordance with our technical specifications.
- If the unit is modified or serviced by unauthorized persons, is improperly maintained (as long as maintenance was not carried out by us), or is handled improperly, Leica will not accept any liability.
- The electric installation in the building must conform to the national standard, e.g. current-operated ground leakage protection (fault-current protection) is suggested.

# Care instructions

## General Instructions

- Protect the stereomicroscope from moisture, fumes and acids and from alkaline, caustic and corrosive materials. Do not store chemicals in the vicinity.
- Protect the stereomicroscope from oil and grease. Never grease or oil mechanical parts or sliding surfaces.
- Follow the instructions of the disinfectant manufacturer.
- We recommend concluding a service contract with Leica Service.

## Cleaning coated parts and plastic parts

- Dust and dirt particles should be removed with a soft brush or lint-free cotton cloth.
- Remove coarse debris with a moistened disposable cloth.
- Acetone, xylene or nitro-containing thinners must NOT be used.
- Never use chemicals to clean colored surfaces or accessories with rubberized parts. This could damage the surfaces, and specimens could be contaminated by abraded particles.

## Cleaning glass surfaces

- Remove dust using a fine, dry and grease-free brush made from hair, by blowing with a squeeze blower, or by using a vacuum.
- Remove dirt using a clean cloth that has been moistened with distilled water.
- Remove tough dirt using alcohol, chloroform or petroleum ether.

# Accessories, maintenance and repair

## Accessories

Only the following accessories may be used with the stereomicroscope:

- The Leica accessories described in this user manual.
- Other accessories, provided that these have been expressly approved by Leica Microsystems as being technically safe in this context.

## Maintenance

- The Leica A60 S stereomicroscope is basically maintenance-free. To ensure that it always operates safely and reliably, we recommend that you take the precaution of contacting the responsible service organization.



You can arrange for periodic inspections or, if appropriate, conclude a maintenance contract with them.

- We recommend concluding a service contract with Leica Service.
- For maintenance and repair, only OEM spare parts may be used.

## Repairs and service work

- Only original Leica Microsystems spare parts may be used.
- Before opening the instruments, switch off the power and unplug the power cable.
- Touching the live circuit can cause injury.

# The Leica A60 S

## Congratulations!

You have just purchased a Leica A60 S - an excellent choice! The outstanding features of this stereomicroscope are its flexible design, its ease of use and absolutely maintenance-free performance. Sturdy and reliable, it is exceptionally well suited to manufacturing tasks, materials testing, quality control and other industrial applications.

In developing the Leica A60 S, we have placed great emphasis on simple, self-explanatory operation. However, please take the time to read the user manual and the notes on operating safety to learn about all the features and capabilities of your stereomicroscope so that you can use it to its best advantage. Should you have any questions, please consult your local Leica representative. We are gladly at your service!

## An Overview of the Leica A60 S

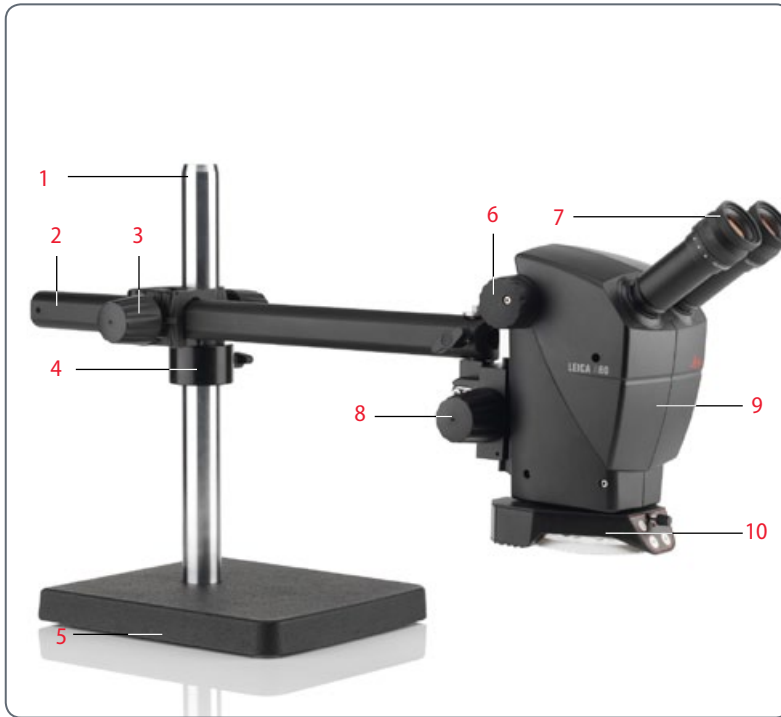

- 1 Column
- 2 Horizontal arm
- 3 Locking screw on the cross-member
- 4 Safety ring
- 5 Baseplate with grounding point
- 6 Magnification changer (zoom)
- 7 Eyepieces
- 8 Focusing drive
- 9 Optics carrier
- 10 Leica A60 LED Ring Illuminator

# Assembling the Leica A60 S

## Column and Baseplate

### Instructions for safe assembly



Due to the heavy weight of the baseplate, improper use can cause injuries or damage to the surrounding area. Therefore, always request assistance for assembly.

### Installing the column

1. Push the tapping screw through the baseplate from below.
2. Fit the serrated lock washer onto the screw.

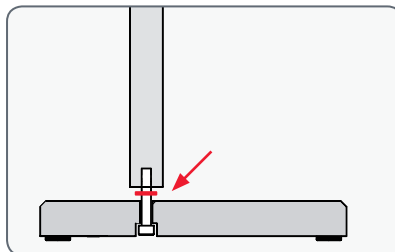

3. Screw the column in place using the Allen key provided.





## Safety Ring and Horizontal Arm

### Installing the Safety Ring

 The safety ring is the most important safety element of the entire configuration. It protects the horizontal arm against falling down accidentally.

1. Slide the safety ring over the column and tighten the clamping screw.



### Mounting the horizontal arm

1. Push the cross-member with the horizontal arm over the column so that the cross-member lies securely on the safety ring. You can now rotate the horizontal arm in any direction desired.



### Fastening the horizontal arm

 For safety reasons, you should fasten the horizontal arm in place when you leave your workstation.

1. Rotate the horizontal arm into a secure position.
2. Carefully tighten the clamping screw on the cross-member.



# Grounding

## Grounding the baseplate



The rear side of the baseplate has a grounding point that you can use to ground the configuration. The grounding cable is not included in the scope of delivery.

## Use

1. Connect the grounding cable to the grounding point of the baseplate.



# Assembling the Optics Carrier

## Assembly

1. Insert the connecting pin from below into the bore of the horizontal arm.
2. Fasten the stereomicroscope using the washer and safety screw.



## Free movement of the stereomicroscope

After you have installed the safety screw, the stereomicroscope can be rotated freely.

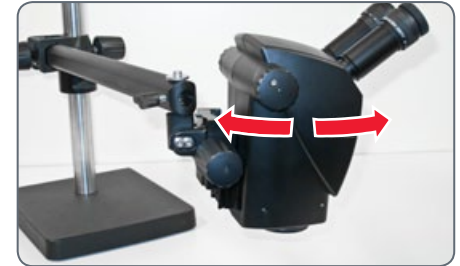

# Fastening the Leica A60

## Fastening



The swing-arm stand is designed so that the Leica A60 S can be moved as desired. However, it may also be logical in some instances to fasten the stereomicroscope in place.

1. Carefully tighten the side clamping screw. This fastens the stereomicroscope in its current position.



## Assembling the Illuminator

### Illuminator assembly

 The Leica A60 LED ring illuminator is installed with a single screw on the bottom of the microscope.

 The ring illuminator can be installed in any side position desired to accommodate the personal preferences of left and right-handed users.





### Assembly

1. Connect the power supply cable to the ring illuminator.
2. Push the ring illuminator as far as it will go and screw it into place.



3. Connect the power supply to the socket.

 The standard delivery of the illuminator includes two Velcro strips that you can use to guide the cable along the horizontal arm.

 The optional diffuser is attached and screwed in below the ring illuminator.



# Using the Leica A60 S

# Adjusting the Working Height

## Working distance



The working distance means the distance between the objective and the specimen in focus. For the Leica A60 S, this is 122 mm.



In addition, the focusing arm of the Leica A60 S provides a travel path of 50 mm that is used for focusing on the specimen. This provides you with plenty of freedom to focus on locations with different heights on a printed circuit board, for example.

## Help for the setup

During setup, use the distance bar provided in the "Quick Start Guide" for orientation:

- Without illuminator, the distance between

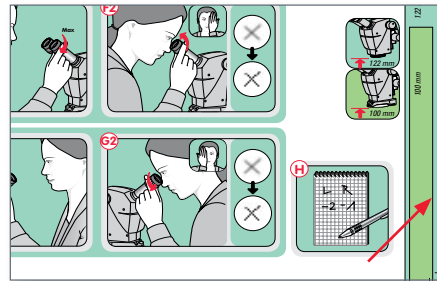

the bottom section of the microscope and the specimen should be 122 mm.

- With the illuminator installed, the distance between the bottom section of the illuminator and the specimen should be 100 mm.

## Safety measures



After each time the working height is adjusted, you have to retighten the safety ring. Otherwise, accidental lowering can cause damage to the specimen or stereomicroscope.

## Adjusting the Working Height (continued)

### Adjusting the working height

1. Hold the horizontal arm securely and release the safety ring.



2. Move the horizontal arm to the desired height.

3. Tighten the locking screw on the cross-member.



4. Guide the safety ring to the cross-member and tighten the clamping screw.



5. Loosen the locking screw on the cross-member so that the horizontal arm can be moved freely again.



## The Correct Interpupillary Distance

The interpupillary distance is correctly set if you see a single circular image field when looking at a specimen.

If you are still a novice stereomicroscope user, you may need a short time to become accustomed to this. Not to worry—after a little while, it will become automatic.



If you wear glasses, fold the eyecups back – otherwise, fold the eyecups forwards.

### Adjusting the interpupillary distance

1. Look into the eyepieces.
2. Hold the eyepieces with both hands. Push

the eyepieces together or separate them until you see a circular image.



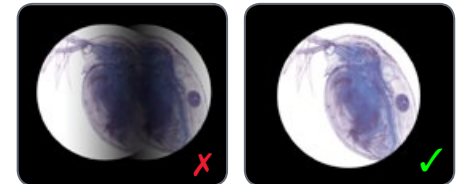

3. Slowly approach the eyepieces with your eyes until you can see the complete image field without corner cutting.



# Focusing

 Focusing raises and lowers the stereo-microscope using the focusing drive. The specimen is brought into sharp focus as soon as it is in the focal point of the optics.

 The focusing drive can be operated either left- or right-handed.

 If precise focusing is not possible, check whether the working distance is in the permitted range (see [page 23](#)).

## Focusing

1. Set the magnification changer to the lowest level (5).



2. Begin to focus on the specimen.



3. Set the magnification changer to the highest level (30).

4. Use the focusing drive for fine focus.

 After the sharpness has been adjusted, it remains constant (parfocal) even when changing the magnification levels – as long as you have configured the diopter settings on the eyepiece correctly for your eyes (see [page 28](#))

## Magnification Display



You can read the configured magnification on the right-hand rotary knob.



For the tables with the optical data, including object field diameter, refer to page 36.

# Dioptric Correction and Parfocality

## Parfocality



Like all other Leica stereomicroscopes, the Leica A60 S is parfocally matched.

The prerequisite for this is the correct setting of the diopters for the respective user. The following adjustments have to be carried out only once by each user.

## Adjusting

1. Set the dioptric correction for both eyepieces to "0".
2. Select the lowest magnification and focus on a flat specimen.

3. Select the highest magnification and readjust the sharpness.
4. Select the lowest magnification again, but do not look into the eyepieces.
6. Rotate the eyepieces counterclockwise in the "+" direction as far as they will go (+5 diopter settings).
7. Look through the left eyepiece only.
8. Turn the eyepiece slowly in the "-" direction until the specimen appears sharp.

9. Look through the right eyepiece and repeat item 8.
10. Select the highest magnification and refocus if necessary.

Now, if you adjust the magnification from the highest to the lowest level, the specimen is always brought into sharp focus. If not, repeat the process. The microscope is now parfocally matched to your eyes.

11. Write down your values and configure them BEFORE each time you begin work. Check the diopter settings at regular intervals.

# Adjusting the Torque of the Focus Drive

## Adjusting the torque

Is the focusing drive too easy or too difficult to adjust? No problem - the torque can be adjusted individually depending on your personal preferences:

1. Grip the drive knobs with both hands and turn them towards each other until the desired torque is reached during focusing.

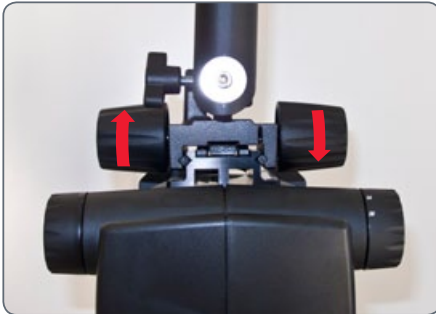

# Leica A60 LED Ring Illuminator





The light of the Leica A60 LED ring illuminator can be very bright. Therefore, always switch on the illuminator *before* you look through the eyepieces! Avoid looking directly into the LEDs.



The ring illuminator offers a great number of advantages you will not want to do without:

- Constant color temperature (daylight) throughout the entire lifecycle
- Long service life of up to 50,000 hours on average
- Absolutely maintenance-free; no lamp replacement required.
- Extremely low power consumption

## Using the keypad

- Use the  button to switch the illuminator on or off.
- Use the  and  buttons to adjust the brightness in 10 increments.
- Touch either of the two buttons to adjust the quantity of light in small increments.
- Hold the button pressed to change the quantity of light more quickly.

## Replacing the Protective Glass



The protective glass protects the optics from dirt and possible damage. Never use the Leica A60 without the protective glass, as otherwise dust and dirt can get into the optics.



The protective glass is considered a consumable. Order number: 10 446 324



Make sure to install the new protective glass as quickly as possible and at a clean location so that no dust or dirt can get inside the microscope.

### Replacing the Protective Glass

1. Remove the Leica A60 LED ring illuminator (see [page 21](#)).
2. Remove the protective glass by carefully turning the bottom of the stereomicroscope.



3. Screw in the new protective glass.

# Dimensions



# Dimensions

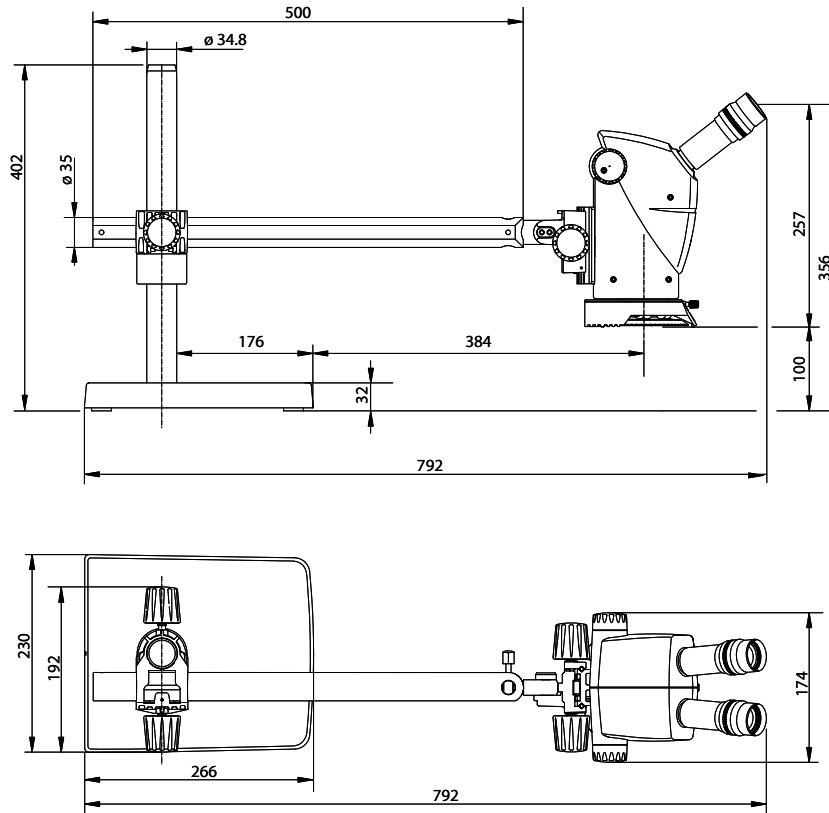

# Optical data

## Optical data

Optical data:			
Zoom Position	Total Magnification	Object Field Diam. mm	Depth of Field*
0.5	5.0	46.0	13.62
0.63	6.3	36.5	9.03
0.8	8.0	28.8	5.89
1.0	10.0	23.0	3.96
1.25	12.5	18.4	2.66
1.6	16.0	14.4	1.71
2.0	20.0	11.5	1.15
2.5	25.0	9.2	0.76
3.0	30.0	7.7	0.54

\* according to Berek