



Genesis Taipan 607/639 (OEM)

High-Power Optically Pumped Semiconductor Powered CW Laser

Features

- OPSSL reliability
- Compact, efficient design
- Modulation rate to >50 kHz
- Ability to deliver high output powers at unique wavelengths
 - 1.25W at 607 nm
 - Up to 2.5W at 639 nm
- Low heat load for ease of integration

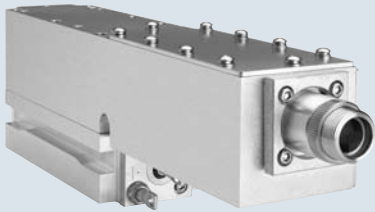

Mechanical Specifications

Front View

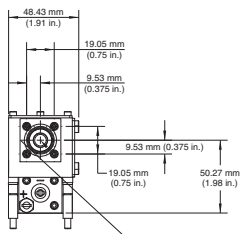

Top View

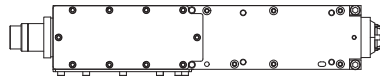

Rear View

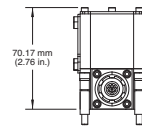

Side View

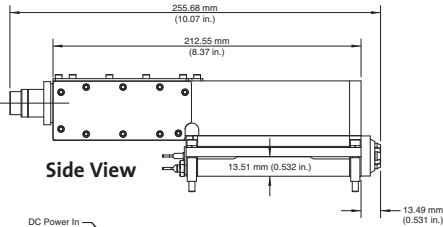

Bottom View

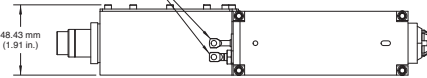

Base Plate Requirements

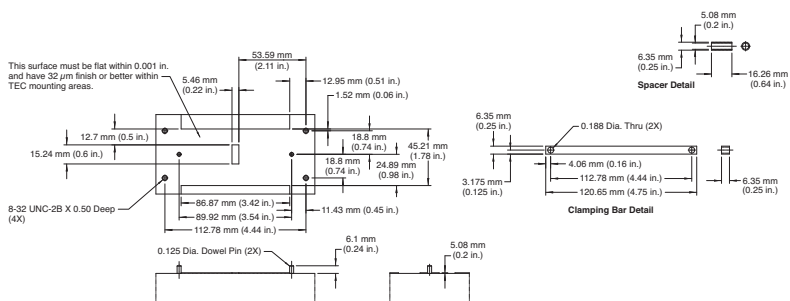

Superior Reliability & Performance

Genesis™ Taipan™ 607/639 (OEM)

High-Power Optically Pumped Semiconductor Powered CW Laser

Optical Specifications¹

Genesis	Taipan 607	Taipan 639
Wavelength (nm)	607 ±1	639 ±1
Output Power (mW)	1250	1500, 2000, 2500
Bandwidth (nm)		<0.5
Collimated Version		
Beam Waist Diameter ² (mm)(FW, 1/e ²)		0.8
Beam Divergence ² (mrad)(FW, 1/e ²)		1.4
Beam Waist Location ^{2,3} (m)		±0.25
M ²		
Horizontal		<1.5
Vertical		<1.5
Pointing Stability ⁴ (µrad/°C)		<10
Noise		
RMS (%) (10 Hz to 10 MHz) ⁷		<5
RMS (%) (10 Hz to 100 kHz) ⁷		<1
Polarization Ratio		Vertical, >100:1
Direct Modulation		Available

Utility and Environmental Requirements

Operating Diode Current (A)	<27	<27, <30, <33
Maximum Diode Current (A)	<32	<32, <35, <38
Diode Voltage (V)		1.5 to 2.2
Cooling Requirements ⁶		Active cooling required
Case Temperature (°C)		20 ±2
Humidity		Non-condensing
Dimensions (L x W x H)		
Laser Head ⁷		256 x 49 x 71 mm (10.07 x 1.93 x 2.76 in.)
Weight		
Laser Head (g)		900 ±10

¹ Optical parameters measured at the output plane of the laser head. Unless noted all parameters valid for the lifetime of the unit.

² Typical value.

³ Measured from the output face, negative value corresponds to a location inside the head; positive outside.

⁴ Measured at the output window: tolerance relative to the nominal center of the output window and perpendicular to the mounting plane.

⁵ Air cooling available with appropriate heat sink and fans.

⁶ Includes collimator.

⁷ At rated power.

Coherent follows a policy of continuous product improvement. Specifications are subject to change without notice.

Coherent's scientific and industrial lasers are certified to comply with the Federal Regulations (21 CFR Subchapter J) as administered by the Center for Devices and Radiological Health on all systems ordered for shipment after August 2, 1976.

Coherent offers a limited warranty for all Genesis Taipan Lasers. For full details of this warranty coverage, please refer to the Service section at www.Coherent.com or contact your local Sales or Service Representative.



www.Coherent.com

U.S. Patent No. 5,991,318
 U.S. Patent No. 6,167,068
 U.S. Patent No. 6,285,702
 U.S. Patent No. 6,438,153
 U.S. Patent No. 6,683,901
 U.S. Patent No. 7,180,928
 Printed in the U.S.A. MC-xxx-11-oM0212
 Copyright ©2012 Coherent, Inc.

Coherent, Inc.
 5100 Patrick Henry Drive
 Santa Clara, CA 95054
 phone (800) 527-3786
 (408) 764-4983
 fax (408) 764-4646
 e-mail tech.sales@Coherent.com

Benelux +31 (30) 280 6060
 China +86 (10) 8215 3600
 France +33 (0)1 8038 1000
 Germany +49 (6071) 968 333
 Italy +39 (02) 31 03 951
 Japan +81 (3) 5635 8700
 Korea +82 (2) 460 7900
 UK +44 (1353) 658 833



ISO 9001:2000 Registered