

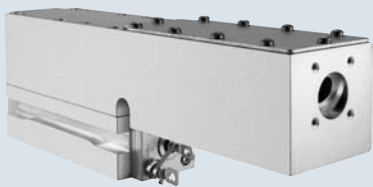

# Genesis MX 607/639 MTM (OEM)

High-Power Optically Pumped Semiconductor Lasers (OPSL)



## Features

- OPSL reliability
- Compact, efficient design
- Modulation rate to >50 kHz
- Ability to deliver high output powers at unique wavelengths
  - 1.25W at 607 nm
  - 1W and 2W at 639 nm
- Low heat load for ease of integration

## Mechanical Specifications

### Front View

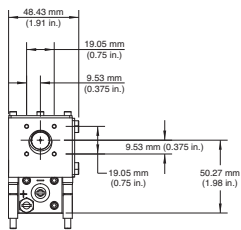

### Top View

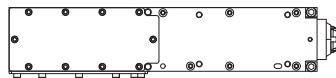

### Side View

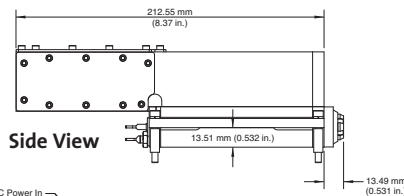

### Rear View

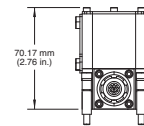

### Bottom View

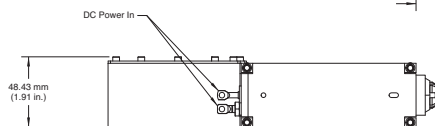

## Base Plate Requirements

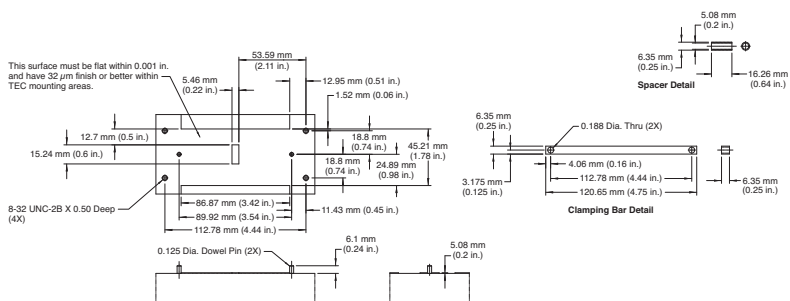

## Superior Reliability & Performance

# Genesis™ MX 607/639 MTM (OEM)

## High-Power Optically Pumped Semiconductor Lasers (OPSL)

### Optical Specifications<sup>1</sup>

Genesis	PRELIMINARY MX 607-1250	PRELIMINARY MX 639-1000/2000
Wavelength (nm)	607 ±1	639.5 ±1
Output Power (mW)	1250	1000, 2000
Spatial Mode	Multimode	
Bandwidth (nm)	<0.5	
Beam Waist Dimensions (mm)		
Horizontal Size <sup>2</sup> (FW, 1/e <sup>2</sup> , mm)	0.25	
Vertical Size <sup>2</sup> (FW, 1/e <sup>2</sup> , mm)	0.25	
Location <sup>2,3</sup> (mm)	-40	
Beam Divergence		
Horizontal <sup>2</sup> (FW, 1/e <sup>2</sup> , mrad)	6	
Vertical <sup>2</sup> (FW, 1/e <sup>2</sup> , mrad)	6	
Collimated Version		
Beam Waist Diameter <sup>2</sup> (FW, 1/e <sup>2</sup> , mm)	0.8	
Beam Divergence <sup>2</sup> (FW, 1/e <sup>2</sup> , mrad)	1.4	
Beam Waist Location <sup>2</sup> (m)	±0.25	
M <sup>2</sup>		
Horizontal	<1.5	
Vertical	<1.5	
Pointing Stability <sup>4</sup> (μrad/°C)	<10	
Noise <sup>6</sup>		
10 Hz to 10 MHz (% rms)	<5	
10 Hz to 100 kHz (% rms)	<1	
Polarization Ratio	Vertical, >100:1	

### Utility and Environmental Requirements

Operating Diode Current (A)	<27	<27, <30
Maximum Diode Current (A)	<32	<32, <35
Diode Voltage (V)	1.5 to 2.2	
Cooling Requirements <sup>5</sup>	Active cooling required	
Case Temperature (°C)	20 ±2	
Humidity	Non-condensing	
Dimensions (L x W x H)		
Laser Head	256 x 49 x 71 mm (10.07 x 1.93 x 2.76 in.)	
Weight		
Laser Head (g)	900 ±10	

<sup>1</sup> Optical parameters measured at the output plane of the laser head. Unless noted all parameters valid for the lifetime of the unit.

<sup>2</sup> Typical value.

<sup>3</sup> Measured from the output face, negative value corresponds to a location inside the head; positive outside.

<sup>4</sup> Measured at the output window; tolerance relative to the nominal center of the output window and perpendicular to the mounting plane.

<sup>5</sup> Water cooling available.

<sup>6</sup> At operating power.

Coherent follows a policy of continuous product improvement. Specifications are subject to change without notice.

Coherent's scientific and industrial lasers are certified to comply with the Federal Regulations (21 CFR Subchapter J) as administered by the Center for Devices and Radiological Health on all systems ordered for shipment after August 2, 1976.

Coherent offers a limited warranty for all Genesis lasers. For full details of this warranty coverage, please refer to the Service section at [www.Coherent.com](http://www.Coherent.com) or contact your local Sales or Service Representative.



[www.Coherent.com](http://www.Coherent.com)

U.S. Patent No. 5,991,318  
U.S. Patent No. 6,167,068  
U.S. Patent No. 6,285,702  
U.S. Patent No. 6,438,153  
U.S. Patent No. 6,683,901  
U.S. Patent No. 7,180,928

Printed in the U.S.A. MC-037-10-0M0212Rev.B  
Copyright ©2012 Coherent, Inc.

**Coherent, Inc.**  
5100 Patrick Henry Drive  
Santa Clara, CA 95054  
phone (800) 527-3786  
(408) 764-4983  
fax (408) 764-4646  
e-mail [tech.sales@Coherent.com](mailto:tech.sales@Coherent.com)

Benelux +31 (30) 280 6060  
China +86 (10) 8215 3600  
France +33 (0)1 8038 1000  
Germany +49 (6071) 968 333  
Italy +39 (02) 31 03 951  
Japan +81 (3) 5635 8700  
Korea +82 (2) 460 7900  
UK +44 (1353) 658 833



ISO 9001:2000 Registered