

Pursuing high precision, speed, and ease of use

Carbon

Sulfur

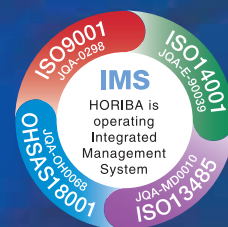

Carbon / Sulfur Analyzer

EMIA

High-frequency induction furnace type

EMIA-920V2/320V2 Series **New**

EMIA-V2/FA (Automatic sampler) **New**

EMIA Automatic Analysis Series **New**

The EMIA Series can be used in a wide range of These models analyze samples efficiently, from

Pursuing high precision, speed, and ease of use.

Elemental analysis is an important factor in determining the characteristics and performance of various materials. In recent years, it has become increasingly important to accurately analyze the carbon and sulfur content in a variety of materials, including steel, electronic materials, catalysts, and alloys. Expertise in analysis - for example pre-treatment - is important in accurately measuring the carbon and sulfur content in various materials. HORIBA offers customers all the support necessary to accommodate increasingly advanced materials; not only by improving the accuracy of the analysis equipment, but also by assisting in actual analysis processes.

Analysis Support Structure

ISO/IEC 17025 Certified Test Site

ISO/IEC 17025 is a standard that applies to test sites and calibration agencies. Certification requirements include items related to operating systems for quality management, as in the case of ISO 9000, as well as essential items related to testing and calibration (e.g., operators' skills, testing facilities, traceability, calibration and testing methods, recording). ISO/IEC 17025 is therefore a very effective standard for objectively evaluating and guaranteeing the reliability of testing and calibration organizations. Test sites with ISO/IEC 17025 certification are authorized to issue test reports bearing an international accreditation mark for test results.

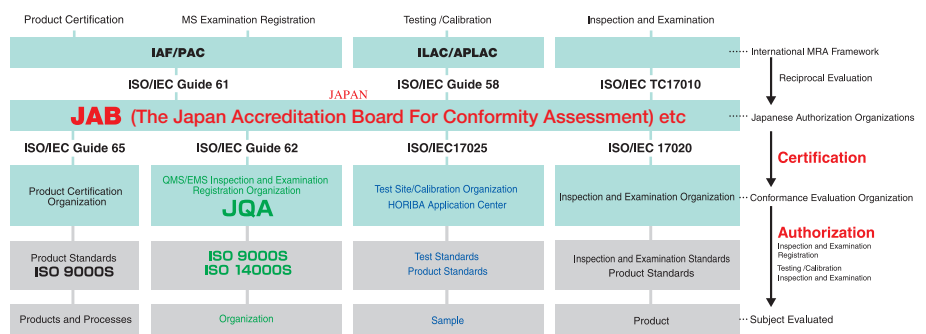

Support structure



material fields, including steel and other alloys.
trace amounts to high concentration range.



Line up

EMIA-920V2 ————— Page. 3

EMIA-320V2 ————— Page. 5

EMIA-V2/FA ————— Page. 6

EMIA-Automated ————— Page. 7

Options

Options ————— Page. 8

Software

Software: Easy Operation ————— Page. 9 and 10

Specifications

Specifications and External Dimensions ————— Page. 11

Application

Application Data ————— Page. 13

High-precision analysis, from trace amounts to the % (m/m) order

Suitable for a wide range of applications, from research to routine analysis

EMIA-920V2 Series

Improved efficiency

Hi-end type

With heating filter (trace amount S analysis)

In samples containing large amount of water, or samples that generate water during combustion, SO₂ gas can be absorbed into the water, thereby affecting the sulfur volumes contained in trace amounts in the sample. The heating filter completely prevent absorption into the water, enabling high-precision analysis. (standard feature in the EMIA-920V2)



Equipped with gas purifier and automatic cleaner as standard features

These devices remove impurities and reduce dust from combustion, two causes of error in trace volume analysis.

Efficient maintenance

Navigation functions further increase ease of use in maintenance.

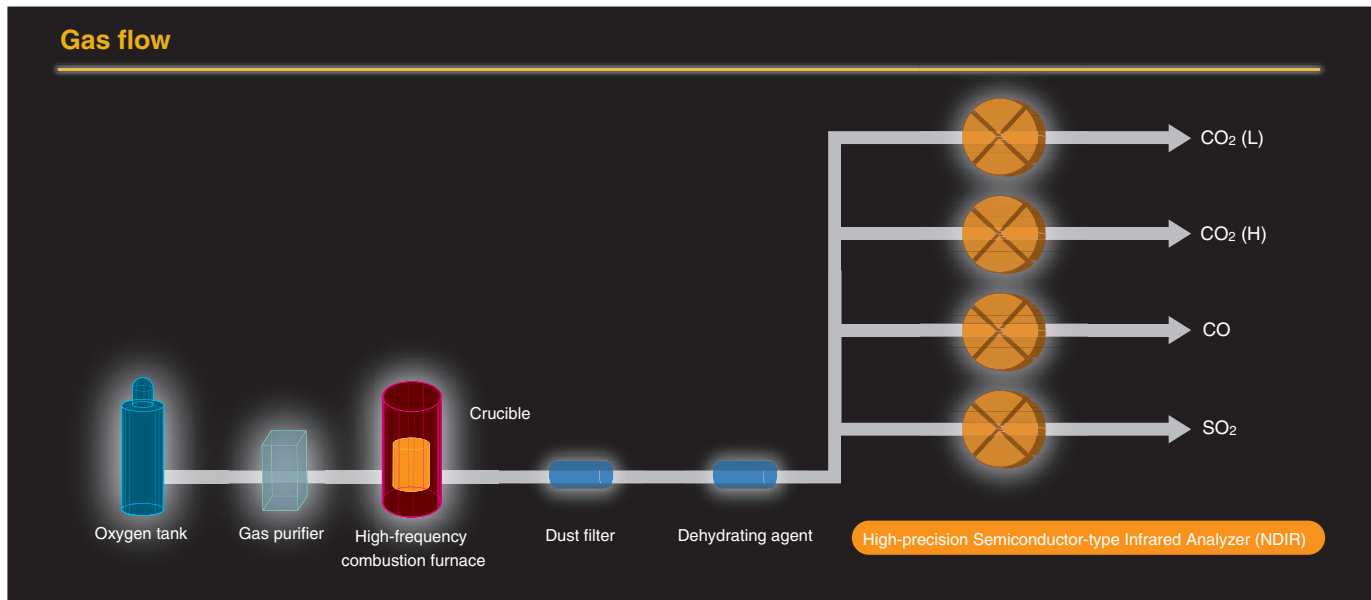

Determination

The combustion control function automatically maintains the plate current at any specified level between 50 and 500 mA. This enables combustion control in keeping with the purpose of the analysis, and ensures high-precision analysis for a variety of samples.

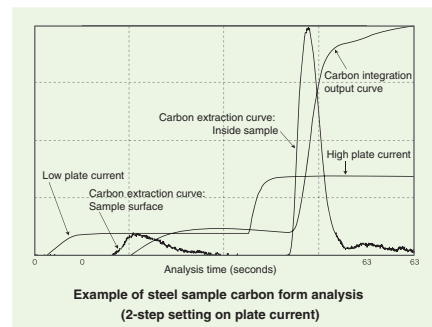

Refined automatic cleaner mechanism improves ease of maintenance.



Mechanisms that improve ease of maintenance



Simple operation, with no tools required

Equipped with twin cleaners

A new type of cleaner that combines gas suction and gas spray



Maintenance navigation is now a standard function

●HORIBA's original maintenance navigation function

Equipment maintenance is essential to ensure highly accurate analysis. The EMIA-920V2's maintenance counter function lets you know when it is time for replacement, and the navigation function provides an easy-to-understand display of the maintenance operations. The analyzer is shown in a 3D display that can be rotated freely to show the area that the operator needs to see. The navigation display shows the procedure for required parts replacement, so day-to-day maintenance can be managed without relying on experience and specialized knowledge.

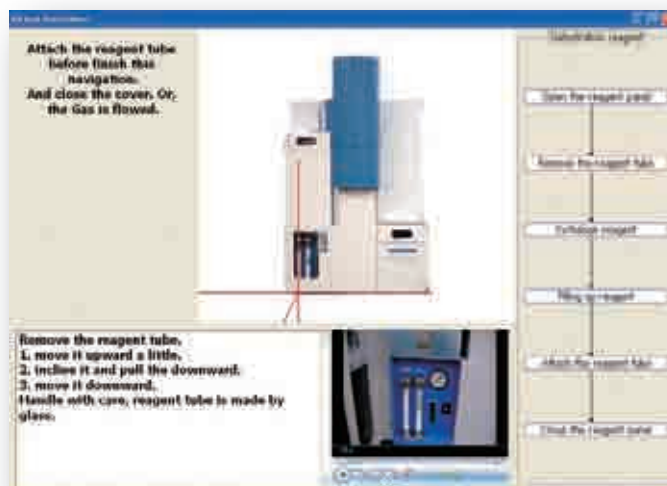

High-precision analysis, from trace amounts to the % (m/m) order

Suitable for routine analysis applications

EMIA-320V2 Series

standard type



(Picture shows automatic cleaner specs)

Select options according to applications

Select the oxygen carrier gas purifier for trace carbon analysis.

(available as an option with EMIA-320V2)

By eliminating minute volumes of THC contained in the carrier gas, this device achieves highly precise measurement for even trace amounts of carbon.

High-frequency furnace automatic cleaner mechanism

(available as an option with EMIA-320V2)

Automated furnace cleaning alleviates the burden of cleaning operations, even when using a variety of measurement samples.

		Model	
		920V2	320V2
Concentration range	Trace amount	[Blue bar]	
	Minute amount		[Blue bar]
	Low concentrations		
	% (m/m) order		
	Automatic cleaner	Standard	Option
	Gas purifier	Standard	Option

EMIA-V2/FA Series

Speed / Reduced power consumption

Automatic cleaner mechanism

Automated furnace cleaning alleviates the burden of cleaning operations, even when using a variety of measurement samples.

Automatic sampler function

Set up to 20 samples; crucibles are automatically loaded into the furnace. All processes are automated, including crucible disposal after measurements.

A variety of analysis sequences can also be selected, including manual insertion of analyses in mid-process.



Automatic sampler

Crucible Pre-heating Unit FK-100

The Crucible Pre-heating unit with the automatic transportation function to heat a ceramic crucible at 1100 degrees Celsius more than ten minutes before analysis

■ Specification

Name	Crucible pre-treatment unit
Type	FK-100
Size	290(W) × 622(D) × 910(H)mm
Mass	40kg
Temp. for use	1000°C - 1100°C
Furnace	Heater : SiC Tube : SiC Thermocouple : R type Thermal Fuse : 110°C Power : 200V ± 10% (50/60Hz) Power consumption : 4kVA (Max)
The number of crucible stock	100pcs (Maximum)
The way of crucible supply	Operated by Electric Cylinder
Utility	Power : AC200V ± 10% (50/60Hz)
Power consumption	4 kVA (Max)



Carbon/Sulfur Analyzer

- Automation system of EMIA
- Fully automated process from sample weighing to post analysis maintenance
- Compact in size to fit into your laboratory
- Easy integration into to your existing automation environment



■ Measurement procedure

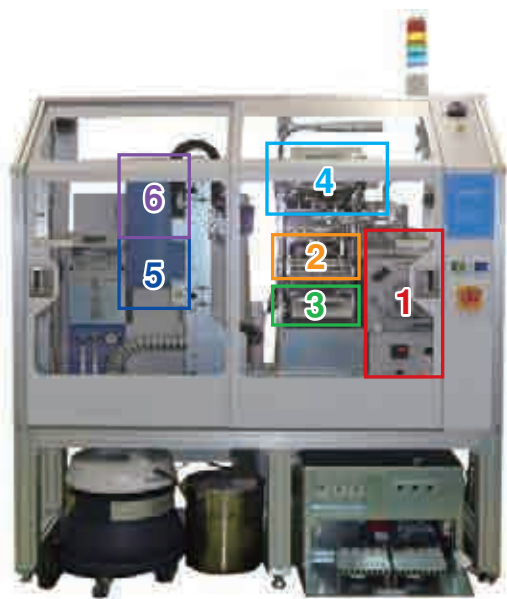

- 1 Crucible pre-heating unit**
Crucible pre-heating unit heat a ceramic crucible at 1100 degrees before analysis.



- 2 Sample stocker unit**
Select the sample from sample stocker with Robot arm.



- 3 Electronic balance**
Weigh the sample.



- 4 Accelerator dispenser unit**
Accelerator dispenser unit dispenses accelerator into crucible.



- 5 Analyser**
Analysis at the analyser unit.

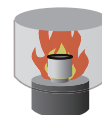

- 6 Auto cleaner unit**
Robot Arm dispose of crucible and cleans up the combustion tube.



Options

Option

	320V2	920V2	320V2/FA	920V2/FA	
Ceramic crucible	<input type="radio"/>	<input type="radio"/>	<input type="radio"/>	<input type="radio"/>	Choose high precision type or low cost type.
Combustion accelerator (tungsten, tin)	<input type="radio"/>	<input type="radio"/>	<input type="radio"/>	<input type="radio"/>	Required to ensure high-efficiency sample combustion.
Automatic Voltage Regulator	<input type="radio"/>	<input type="radio"/>	<input type="radio"/>	<input type="radio"/>	With input of AC 200/220 V, guarantees output of $\pm 15\%$, and AC 200 V $\pm 1\%$ stability
Regulator (decompression valve)	<input type="radio"/>	<input type="radio"/>	<input type="radio"/>	<input type="radio"/>	Controls gas from the carrier gas tank, for supply to the main unit. Dual stage regulator for Oxygen and Nitrogen
Compressor	<input type="radio"/>	<input type="radio"/>	<input type="radio"/>	<input type="radio"/>	Supplies operating air to drive the main unit.
Halogen trap unit	<input type="radio"/>	<input type="radio"/>	<input type="radio"/>	<input type="radio"/>	Traps gas generated when measuring samples containing halogen, to prevent damage to the main unit
Automatic cleaner	<input type="radio"/>	<input checked="" type="radio"/>	<input checked="" type="radio"/>	<input checked="" type="radio"/>	Automatically cleans the inside of the furnace after measurement
Carrier gas purifier	<input type="radio"/>	<input checked="" type="radio"/>	<input type="radio"/>	<input checked="" type="radio"/>	Removes impurities (mainly hydrocarbons) from the carrier gas, to increase accuracy (repeatability) for carbon in low concentration ranges

○: Option ●: Standard feature

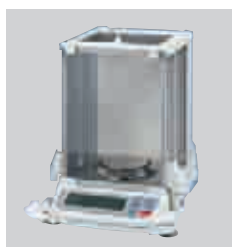

Electronic balance



Ceramic crucible



Combustion accelerator (tungsten, tin)



Automatic Voltage Regulator



Regulator (decompression valve)

Built-in software enables easy operation, from measurement to maintenance

Software

Basic measurement screen
(EMIA-920V2/320V2)

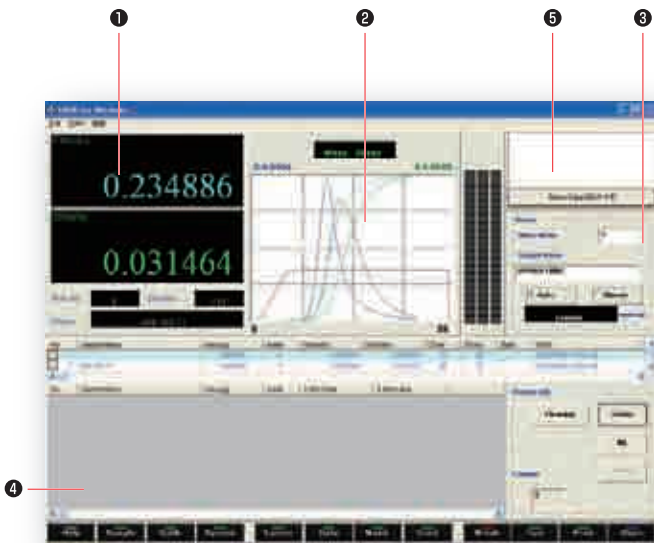

- ① Display of analysis results: Extracted carbon and sulfur gas signal values are displayed in real time during the analysis.
- ② Carbon and sulfur extraction graph and plate current values are displayed in real time during the analysis. Extraction graphs can be saved automatically (available on EMIA-920V2 and 320V2).
- ③ Input the measurement mode, sample name, and sample weight. Sample weight can be sent automatically from the balance.
- ④ Measurement results are displayed on the upper segment of the screen, and scheduled measurements are displayed on the lower segment.
- ⑤ When alarms sound, alarms are displayed in order of priority. (All sounding alarms can also be displayed in a separate list.)

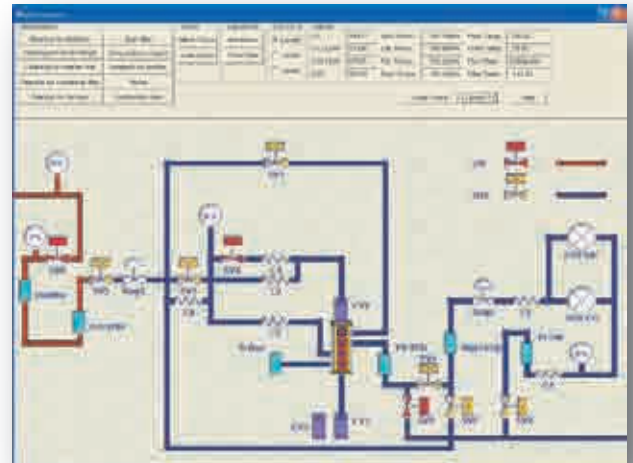

Maintenance screen

Automatically checks for leaks after maintenance (e.g., replacement of combustion tubes or reagents). The area being checked is displayed on the screen, for easy monitoring by the operator.



Counter screen

This screen notifies the user of approaching schedules for regular maintenance items (reagents, etc.).

Central management of maintenance operations

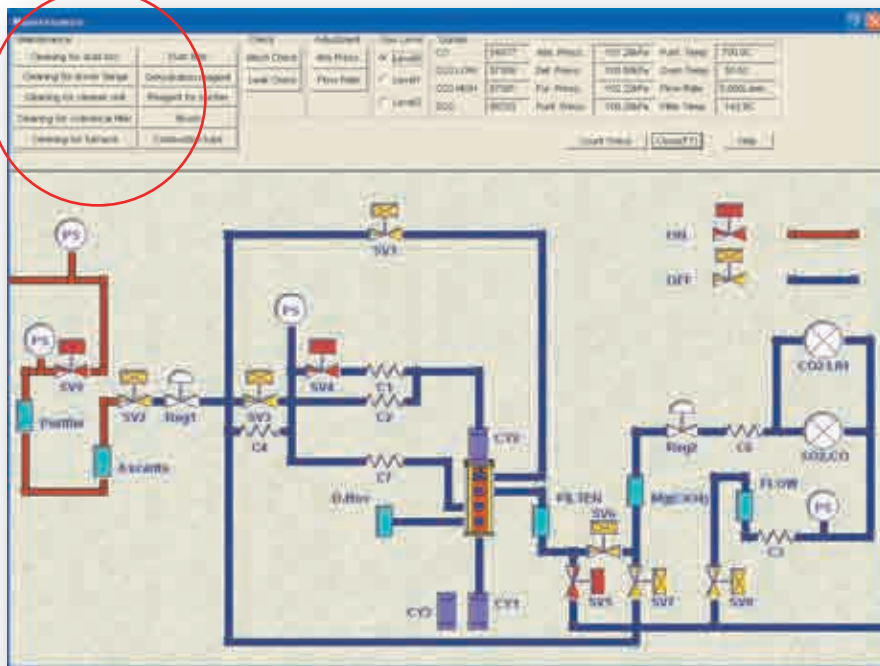

This screen enables batch management of maintenance items requiring day-to-day checks (to prevent maintenance oversights)

Manual-free maintenance eliminates variations in performance arising from differences in operator skills.

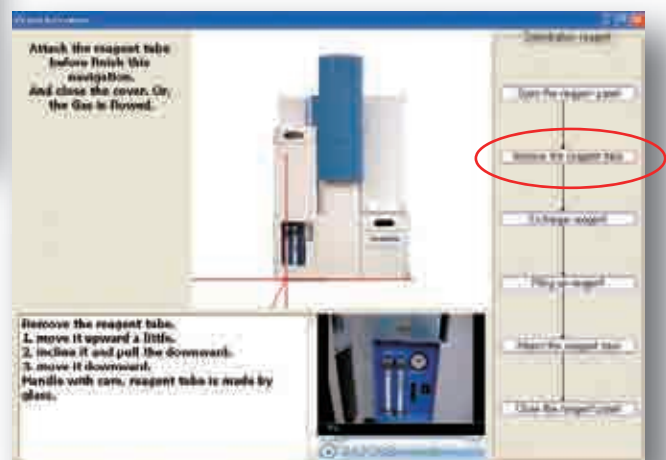
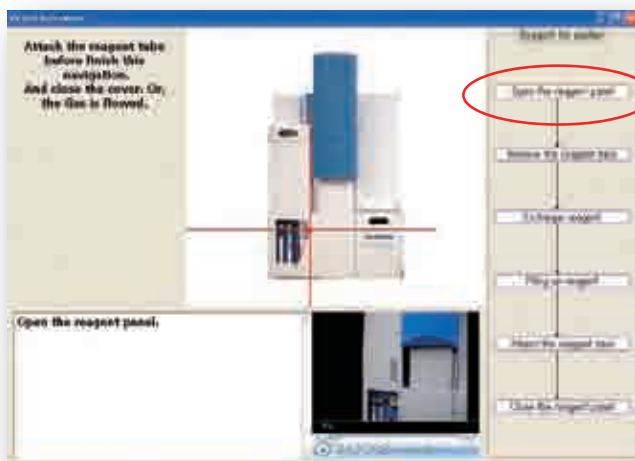

Specifications and External Dimensions

Model name	EMIA-920V2 Series Carbon/Sulfur Analyzers	EMIA-320V2 Series Carbon/Sulfur Analyzers
Carbon/sulfur	EMIA-920V2	EMA-320V2
Carbon	EMA-921V2	EMA-321V2
Sulfur	EMA-922V2	EMA-322V2

Hardware

Measurement method	High-frequency heating in oxygen stream – Infrared absorption method	
Measuring range	Carbon: 0-6% (m/m) Sulfur: 0-1% (m/m) Measurement range can be expanded by reducing sample weight below standard weight	
Sensitivity (minimum reading)	For both carbon and sulfur: 0.000001% (m/m) (0.01 ppm)	For both carbon and sulfur: 0.00001% (m/m) (0.1 ppm)
Accuracy (repeatability)	Carbon Less than 0.0020% (m/m): $\sigma_{n-1} \leq 0.00003\%$ (m/m) *1, *2 0.0020% (m/m) or more: $\sigma_{n-1} \leq 0.0001\%$ (m/m) or CV $\leq 0.5\%$	$\sigma_{n-1} \leq 0.0002\%$ (m/m) or CV $\leq 1.0\%$ *1, *2
Sulfur	Less than 0.0020% (m/m): $\sigma_{n-1} \leq 0.00003\%$ (m/m) *1, *2 0.0020% (m/m) or more: $\sigma_{n-1} \leq 0.0001\%$ (m/m) or CV $\leq 0.75\%$	$\sigma_{n-1} \leq 0.0002\%$ (m/m) or CV $\leq 1.5\%$ *1, *2
Standard sample weight	1.0 g	
Weight input	0.000001 - 99.999999 g Weight can be input from optional electronic scale or manually	
Display	LCD	
High-frequency combustion furnace	Oscillation frequency: $20 \leq 2$ MHz Anode output: 2.3 kW Plate current: 10 steps can be set, up to 500 mA	
Integration conditions	Select from comparator integration, time integration, or a combination of the two	
Sample ID	Up to 20 single-byte characters	
Calibration, etc.	(1) One-point or multi-point calibration using standard sample (2) Multi-point least squares first order approximation method (3) Calibration formulas: 16 formulas can be stored in memory (numerical input OK) (4) Calibration data rejection (5) Measurement data transfer	
Functions	(1) Mid-process measurement: Editing of measurement order (2) Self diagnosis: Alarm display, maintenance counter (3) Measurement result memory: Storage of measurement results (4) Graph data memory: Storage of gas extraction curves (5) Statistical calculation: Average, range, SD, CV calculation, and graph display	
External dimensions and weight	Main unit: (W) 619 x (D) 928 x (H) 953 mm; approx. 170 kg	
Control PC	PC/AT compatible PC running Windows XP	

Common utilities

Power source	(1) Voltage: Main unit: Specify 200 V, 220 V, or 240 V, PC: 110 V, 120 V, 200 V, 220 V, 240 V (2) Voltage fluctuation: Standard voltage +10% or less (3) Frequency: 50/60 Hz ≤ 1 Hz (4) Power: Main unit: 5 kVA, PC: 0.5 kVA, Cleaner: 1 kVA (5) Ground: Type A or Special Type D independent earth (Earth resistance: 10 Ω or less)	
Ambient conditions	(1) Temperature: Operating temp.: 5 - 40°C, Performance temp.: 5 - 35°C (2) Humidity: Max. RH 80% at 5 - 31°C, At 31 - 40°C: Linear decrease to RH 50% (3) Vibration: Amplitude 20 μ m and 0.098 m/S ² or less acceleration in all frequency bands	
Gas	Oxygen (for combustion): Supply pressure: 0.30 MPa Purity: 99.5% or more Nitrogen (for air cylinder drive and gas spray): Supply pressure: 0.35 MPa	
Options	(1) Electronic scale: The range of readout recommends the balance of 61g - 0.1mg (2) Constant voltage power supply: Capacity: 5 kVA (specify input voltage at time of order) (3) Crucible pre-heater: Furnace temp.: 1,100°C; with automatic transport function (4) External output of measurement results: RS-232C output	(1) Electronic scale: Made by A&D Weighing (can be connected from 1 to 0.01 mg) (2) Constant voltage power supply: Capacity: 5 kVA (specify input voltage at time of order) (3) Crucible pre-heater: Furnace temp.: 1,100°C; with automatic transport function (4) External output of measurement results: RS-232C output (5) Automatic cleaner: Automatically cleans inside of combustion furnace (built into main unit) (6) Carrier gas purifier: Purifies oxygen (built into main unit)

*1: Using highly reliable standard steel sample.

*2: Ceramic crucible pre-heated at 1,000°C for more than 30 min.

*The EMIA-V Series uses high frequencies, so notification must be given to the telecommunications bureau with jurisdiction.

EMIA-920V2, EMIA-320V2 (with Auto cleaner)

EMIA-320V2 (without Auto cleaner)

EMIA-920V2/FA, EMIA-320V2/FA

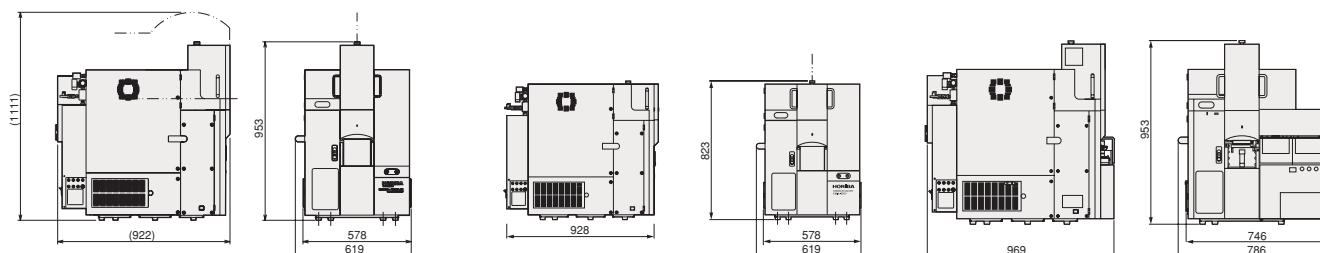

Automation system of EMIA

■ Specification of Automation system of EMIA

Size & Weight	1300(W) × 1200(D) × 1700(H)mm : 500kg
Sample shape	Block or Pin shape (smaller than $\varnothing 8\text{mm}$ / 15mm(H))
Through put time (*Depending on measurement condition)	Approximately 60 seconds for measurement
Operating mode	<ul style="list-style-type: none"> · Full-Automation (ON LINE / OFF LINE) · Semi-Automation · Manual

■ Dimensional outline drawing

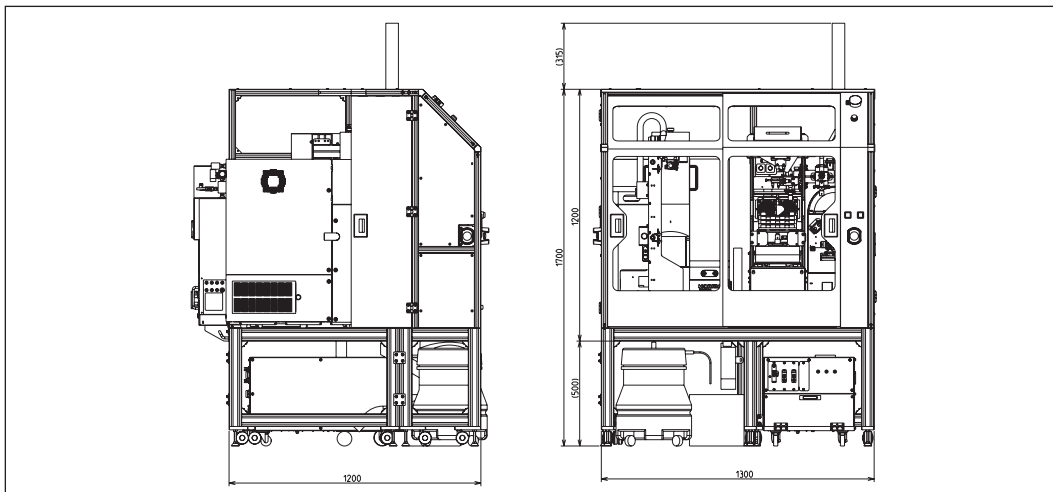

■ Dimensional outline drawing

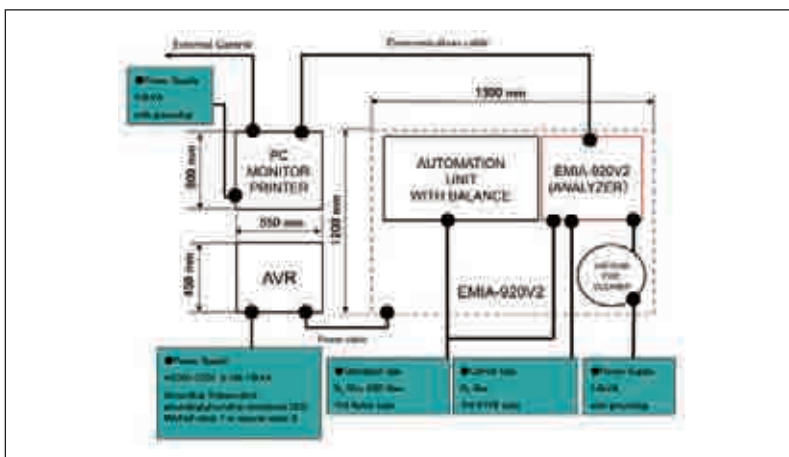

Application Data

EMIA-920V2

Example of steel sample analysis (carbon)

	JSS1201-1*	JSS155-1	JSS150-1	JSS111-12
Standard value (% (m/m))	0.0005	0.041	0.48	4.25
1	0.000495	0.041051	0.482026	4.241809
2	0.000506	0.041230	0.485202	4.269519
3	0.00050	10.041012	0.486187	4.236444
4	0.000479	0.041014	0.486486	4.258657
5	0.00047	0.040812	0.483148	4.251581
Average	0.000490	0.04102	0.48461	4.25160
σ_{n-1}	0.000015	0.00015	0.00195	0.01320
CV(%)	3.10	0.36	0.40	0.31

Heat treatment at 400 C
With Cu combustion accelerator

Example of steel sample analysis (sulfur)

	JSS003-3	JSS606-8	JSS155-1	JSS150-14
Standard value (% (m/m))	(0.00019)	0.0008	0.0060	0.030
1	0.000176	0.000803	0.006204	0.030182
2	0.000162	0.000839	0.006292	0.030181
3	0.000172	0.000815	0.006204	0.029903
4	0.000174	0.000823	0.006274	0.030110
5	0.000185	0.000796	0.006204	0.029888
Average	0.000174	0.000815	0.00624	0.03005
σ_{n-1}	0.000008	0.000017	0.00004	0.00015
CV(%)	4.75	2.08	0.70	0.49

HORIBA continues contributing to the preservation of the global environment through analysis and measuring technology.



Please read the operation manual before using this product to assure safe and proper handling of the product.

- The contents of this catalog are subject to change without prior notice, and without any subsequent liability to this company.
- The color of the actual products may differ from the color pictured in this catalog due to printing limitations.
- It is strictly forbidden to copy the content of this catalog in part or in full.
- All brand names, product names and service names in this catalog are trademarks or registered trademarks of their respective companies.

<http://www.horiba.com> e-mail: info@horiba.co.jp

● HORIBA, Ltd.

Head Office
Miyano Higashi, Kisshoin
Minami-ku, Kyoto, Japan
Phone: 81 (75) 313-8123
Fax: 81 (75) 321-5725

Tokyo Sales Office
1-7-8 Higashi-Kanda
Chiyoda-ku, Tokyo, Japan
Phone: 81 (3) 3861-8231
Fax: 81 (3) 3861-8259

TAIWAN Representative Office
3F, NO.18 Lane 676, Chung
Hua Rd, Chupei City,
Hsinchu Hsien, 302, Taiwan
Phone: 886 (3) 656-1012
Fax: 886 (3) 656-8231

● HORIBA TRADING (SHANGHAI) CO., Ltd.

Shanghai Office
Room 1701, United Plaza,
1468 Nanjing Rd. West,
Shanghai, 200040, China
Phone: 21-6289-6060
Fax: 21-6289-5553

Beijing Office
Room 1801, Capital Tower,
Beijing, Tower 1 No.6Jia,
Jianguomenwai Ave.,
Chaoyang District, Beijing,
100022 China
Phone: 10-8567-9966
Fax: 10-8567-9066

● HORIBA KOREA Ltd.

112-6 Sogong-Dong
Choong-ku, Seoul, Korea
Phone: 82 (2) 753-7911
Fax: 82 (2) 756-4972

● HORIBA INSTRUMENTS

Pte. LTD.
10 Ubi Crescent
#05-11/12, Ubi Techpark
Singapore 408564
Phone: 65 6745-8300
Fax: 65 6745-8155

● HORIBA JOBIN YVON S.A.S.
16-18 rue du Canal, 91165
Longjumeau Cedex, France
Phone: 33 (1) 64-54-13-00
Fax: 33 (1) 69-09-07-21

● HORIBA Jobin Yvon Ltd.
2 Dalston Gardens, Stanmore,
Middlesex HA7 1BQ, England,
UK
Phone: 44 (208) 204-81-42
Fax: 44 (208) 204-61-42

● HORIBA JOBIN YVON Srl
Via Cesare Pavese 35/AB,
20090 Opera, Milano, Italy
Phone: 39 (2) 57-60-30-50
Fax: 39 (2) 57-60-08-76

● HORIBA JOBIN YVON S.A.S.
Spain Branch
P.A.E. Neisa Norte, Avenida
Valdelaparra 27 Edificio
1 Bajo 3 Madrid 28108
Alcobendas Spain
Phone : +34 91 490 23 34
Fax : +34 91 484 13 13

● HORIBA Jobin Yvon GmbH
HORIBA Jobin Yvon GmbH work
Hauptstr.182008 Unterhaching Germany
Phone : +49 89 46 23 17-0
Fax : +49 89 46 23 17-99

● HORIBA JOBIN YVON Inc.
3880 Park Avenue
Edison, NJ 08820
U.S.A.
Phone: 1 (732) 494-8660
Fax: 1 (732) 549-5125

Bulletin:HRE-3751A

Printed in Japan T-G(SK)13